

INSTALLATION AND OPERATING INSTRUCTIONS

MODEL KBAC-24D

Adjustable Frequency Drive for 3-Phase AC Motors

NEMA 4X, IP-65

KB Part No. 9987 (Black Case) • Part No. 9988 (White Case)

Rated for 208 - 230 Volt 50/60 Hz Induction Motors thru 1 HP
Operates from 115 or 208/230 Volt 50/60 Hz Single Phase AC Line Input
Washdown and Watertight for Indoor and Outdoor Use

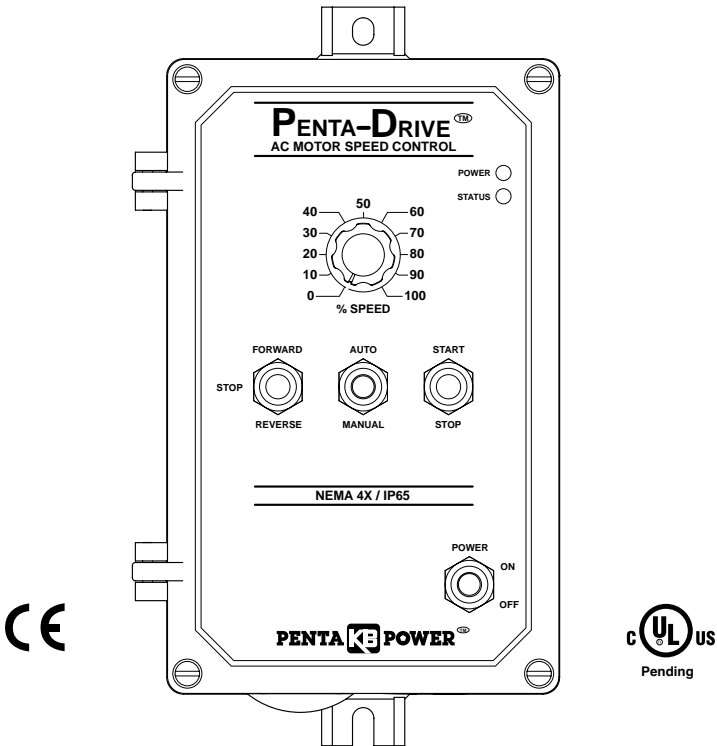

See Safety Warning on Page 2

The information contained in this manual is intended to be accurate. However, the manufacturer retains the right to make changes in design which may not be included herein.

PENTA  POWER TM

A COMPLETE LINE OF MOTOR DRIVES

© 2000 KB Electronics, Inc.

TABLE OF CONTENTS

| Section | Page |
|---|-------------|
| i. Simplified Operating Instructions | 1 |
| ii. Safety Warning | 2 |
| I. Introduction | 2 |
| II. Wiring Instructions | 6 |
| III. Setting Selectable Jumpers | 8 |
| IV. Mounting Instructions | 9 |
| V. Recommended High Voltage Dielectric Withstand Testing (Hi-Pot) | 9 |
| VI. Control Operation | 10 |
| VII. AC Line Fusing | 11 |
| VIII. Trimpot Adjustments | 11 |
| IX. Diagnostic LEDs | 13 |
| X. Optional Accessories | 13 |
| XI. Limited Warranty | 14 |
| Tables | |
| 1. Electrical Ratings | 3 |
| 2. General Performance Specifications | 6 |
| 3. Terminal Block Wiring Information | 7 |
| 4. Fault Recovery and Resetting the Control | 11 |
| 5. Control Mode and Status LED Indication | 13 |
| Figures | |
| 1. Control Layout | 4 |
| 2. Enlarged View of Trimpot Settings | 4 |
| 3. Mechanical Specifications | 5 |
| 4. Power Connections | 7 |
| 5. Remote Main Speed Potentiometer Connection | 7 |
| 6. Remote Start/Stop Switch Connection | 7 |
| 7. Start/Stop Function Eliminated (Jumper Installed) | 7 |
| 8. Voltage Following Connection | 8 |
| 9. Enable Circuit Connection | 8 |
| 10. AC Line Input Voltage Selection (J1 and J2) | 8 |
| 11. Motor Horsepower Selection (J3) | 8 |
| 12. Reset Mode Selection (J4) | 9 |
| 13. Motor Frequency Selection (J5) | 9 |
| 14. Motor Frequency Multiplier Selection (J6) | 9 |
| 15. Boost Mode Selection (J7) | 9 |
| 16. Hi-Pot Setup | 10 |
| 17. MAX Trimpot Range | 11 |
| 18. MIN Trimpot Range | 11 |
| 19. ACCEL Trimpot Range | 11 |
| 20. DECEL Trimpot Range | 12 |
| 21. COMP Trimpot Range | 12 |
| 22. CL Trimpot Range | 12 |
| 23. I ² t Trip Time vs Motor Current | 12 |
| 23. BOOST Trimpot Range | 13 |

i. SIMPLIFIED OPERATING INSTRUCTIONS

IMPORTANT – You must read these simplified operating instructions before proceeding. These instructions are to be used as a reference only and are not intended to replace the detailed instructions provided herein. You must read the Safety Warning, on page 2, before proceeding.

Application Information – Most totally enclosed fan-cooled (TEFC) and open ventilated 3-phase motors will overheat if used with an inverter beyond a limited speed range at full torque. Therefore, it is necessary to reduce motor load as speed is decreased.

Note: Some fan-cooled motors can be used over a wider speed range. Consult motor manufacturer for details.

 **WARNING!** There are some motors whose characteristics cause overheating and winding failure under light load or no load conditions. If the motor is operated in this manner for an extended period of time, it is recommended that the unloaded motor current be checked from 2-15 Hz (60-450 RPM) to ensure motor current does not exceed the nameplate rating. **Do not use motor if the motor current exceeds the nameplate rating.**

Inverter duty and most totally enclosed non-ventilated (TENV) motors can provide full rated motor torque over an extended speed range without overheating.

 **It is recommended that this control be used with Inverter Duty or TENV motors.**

If external fan-cooling is provided, open-ventilated motors can also achieve an extended speed range at full rated torque. A box fan or blower with a minimum of 100 CFM is recommended. Mount the fan such that the motor is surrounded by the airflow.

 **WARNING! Disconnect main power when making connections to the control.**

- A. AC Line Connection** – Connect the AC line to L1 and L2 terminals of Terminal Block TB1 and the ground wire (Earth) to the green ground screw as shown in Figure 4, on page 7, and as described in Section IIA, on page 7, and Section IIB, on page 7. Set Jumpers J1 and J2 to the corresponding AC line input voltage (115 or 208/230 Volts AC).
- B. Motor Connection** – Connect the motor to U, V and W terminals of Terminal Block TB1 as shown in Figure 4, on page 7, and as described in Section IIC, on page 7. Motor cable length should not exceed 100 feet (30m) – special reactors may be required – contact the Sales Department.
- C. Start/Stop Switch** – The control is supplied with a prewired Start/Stop Switch as described in Section IIE, on page 7, which is used to start and stop the control. In Manual Start Mode, this switch must be used to start the control each time the AC power is lost or the control shuts down due to a fault.
- D. Jumper Settings** – All jumpers are factory set for most applications. Be sure Jumper J3 is set to the correct motor HP. See Section IIIB, on page 8.
- E. AC Line Fusing** – Install a fuse or circuit breaker in the AC line. Fuse each conductor that is not at ground potential. See Section VII, on page 11, for recommended fuse size.
- F. Trimpot Settings** – All trimpots have been factory set as shown in Figure 2, on page 4. Trimpots may be readjusted as described in Section VIII, on page 11.
- G. Diagnostic LEDs** – After power has been applied, observe the LEDs to verify proper control operation as described in Section IX, on page 14.

ii.  **SAFETY WARNING! Please read carefully**

This product should be installed and serviced by a qualified technician, electrician, or electrical maintenance person familiar with its operation and the hazards involved. Proper installation, which includes wiring, mounting in proper enclosure, fusing or other overcurrent protection, and grounding can reduce the chance of electrical shocks, fires, or explosion in this product or products used with this product, such as electric motors, switches, coils, solenoids, and/or relays. Eye protection must be worn and insulated adjustment tools must be used when working with control under power. This product is constructed of materials (plastics, metals, carbon, silicon, etc.) which may be a potential hazard. Proper shielding, grounding, and filtering of this product can reduce the emission of radio frequency interference (RFI) which may adversely affect sensitive electronic equipment. If further information is required on this product, contact the factory. It is the responsibility of the equipment manufacturer and individual installer to supply this Safety Warning to the ultimate end user of this product. (SW effective 11/1992.)

This control contains electronic Start/Stop circuits that can be used to start and stop the control. However these circuits are never to be used as safety disconnects since they are not fail-safe. Use only the AC line for this purpose.

Be sure to follow all instructions carefully. Fire and/or electrocution can result due to improper use of this product.

 This product complies with all CE directives pertinent at the time of manufacture. Contact factory for detailed installation and Declaration of Conformity. Installation of a CE approved RFI filter (KBRF-300 [P/N 9484] or equivalent) is required. Additional shielded motor cable and/or AC line cables may be required along with a signal isolator (SIAC [P/N 9488] or equivalent).

I. INTRODUCTION

Thank you for purchasing the KBAC-24D. KB Electronics, Inc. is committed to providing total customer satisfaction by producing quality products that are easy to install and operate. The KBAC-24D is manufactured with surface mount components incorporating advanced circuitry and technology.

The KBAC-24D Adjustable Frequency Drive is a variable speed control in a NEMA-4X / IP-65 washdown and watertight enclosure. It is designed to operate 208 - 230 Volt 3-phase AC induction motors through 3.6 Amps RMS. The sine wave coded Pulse Width Modulated (PWM) output, which operates at a frequency of 16 kHz, provides high motor torque, high efficiency and low noise. The control operates from 115 or 208/230 Volt 50/60 Hz single phase AC line input.

Due to its user friendly design, tailoring the KBAC-24D to specific applications is easily accomplished via selectable jumpers and trimpot adjustments. This eliminates the computer-like programming required on other drives. However, for most applications no adjustments are necessary.

Main features include adjustable RMS Current Limit and I²t Motor Overload Protection. In addition, Adjustable Slip Compensation provides excellent load regulation over a wide speed range. Power Start™ delivers over 200% motor torque to ensure startup of high frictional loads. Electronic Inrush Current Limit (EICL™) eliminates harmful AC line inrush current and Adjustable Linear Acceleration and Deceleration make the drive suitable for soft-start applications. Additional features include holding torque at zero speed and ride-through which provides a smooth recovery to the previous set speed during a momentary power loss.

Standard front panel features include diagnostic LEDs for power on and control status, a Start/Stop Switch and a Main Speed Potentiometer. Other features include a Barrier Terminal Block to facilitate wiring of the AC line and motor, adjustable trimpots (MAX, MIN, ACCEL, DECEL, COMP, CL, BOOST) and selectable jumpers (line voltage, motor horsepower, auto or manual reset modes, motor frequency, frequency multiplier, fixed or adjustable boost).

Optional accessories include a Forward-Stop-Reverse Switch, Power On/Off Switch, Signal Isolator, Auto/Manual Switch, and Multi Speed Board. Quick-connect terminals are provided for easy installation of all accessories.

STANDARD FEATURES

- **Motor Overload Protection (I²t)*** – Provides motor overload protection which prevents motor burnout and eliminates nuisance trips.
- **Power Start™** – Provides more than 200% starting torque and ensures startup of high frictional loads.
- **Electronic Inrush Current Limit (EICL™)** – Eliminates harmful inrush AC line current during startup.
- **Dual Voltage Input** – The control operates from 115 or 208/230 Volt 50/60 Hz single phase AC line Input.
- **Horsepower Selection** – The control contains a horsepower selection jumper which eliminates the need to recalibrate the CL trimpot for different motors.
- **Short Circuit Protection** – Shuts down the control if a short circuit occurs at the motor (phase-to-phase).
- **Regeneration Protection** – Eliminates tripping due to bus overvoltage caused by rapid deceleration of high inertial loads.
- **Slip Compensation with Boost** – Provides excellent load regulation over a wide speed range.
- **Start/Stop Switch** – Provides electronic start and stop.
- **Ride-Through** – Provides smooth recovery to the previous set speed during a momentary power loss.
- **Diagnostic LEDs** – Power on (POWER) and control status (STATUS).
- **Barrier Terminal Block** – Facilitates wiring of motor and AC line.
- **Protection Features** – Undervoltage and overvoltage protection. MOV input transient protection. Microcontroller self-monitoring and auto reboot. Short circuit protected phase-to-phase at motor.
- **Industrial Duty Die-Cast Aluminum Case** – Available in black finish (P/N 9987) or white FDA approved finish (P/N 9988).
- **Holding Torque at Zero Speed** – Resists motor shaft rotation when the control is in stop mode.

Note: * UL approved as an electronic overload protector for motors.

TABLE 1 – ELECTRICAL RATINGS

| AC Line Input Voltage ±10%, 50/60 Hz (Single Phase Volts AC) | Maximum AC Line Input Current (Amps AC) | Nominal Output Voltage (Volts AC) | Maximum Continuous Output Load Current (RMS Amps/Phase) | Maximum Horsepower Rating HP, (kW) |
|--|---|---|---|--|
| 115 | 16 | 0 – 230 | 3.6 | 1, (0.75) |
| 208/230 | 10 | 0 – 230 | 3.6 | 1, (0.75) |

FIGURE 1 – CONTROL LAYOUT

(Illustrates Factory Setting of Jumpers and Approximate Trimpot Settings)

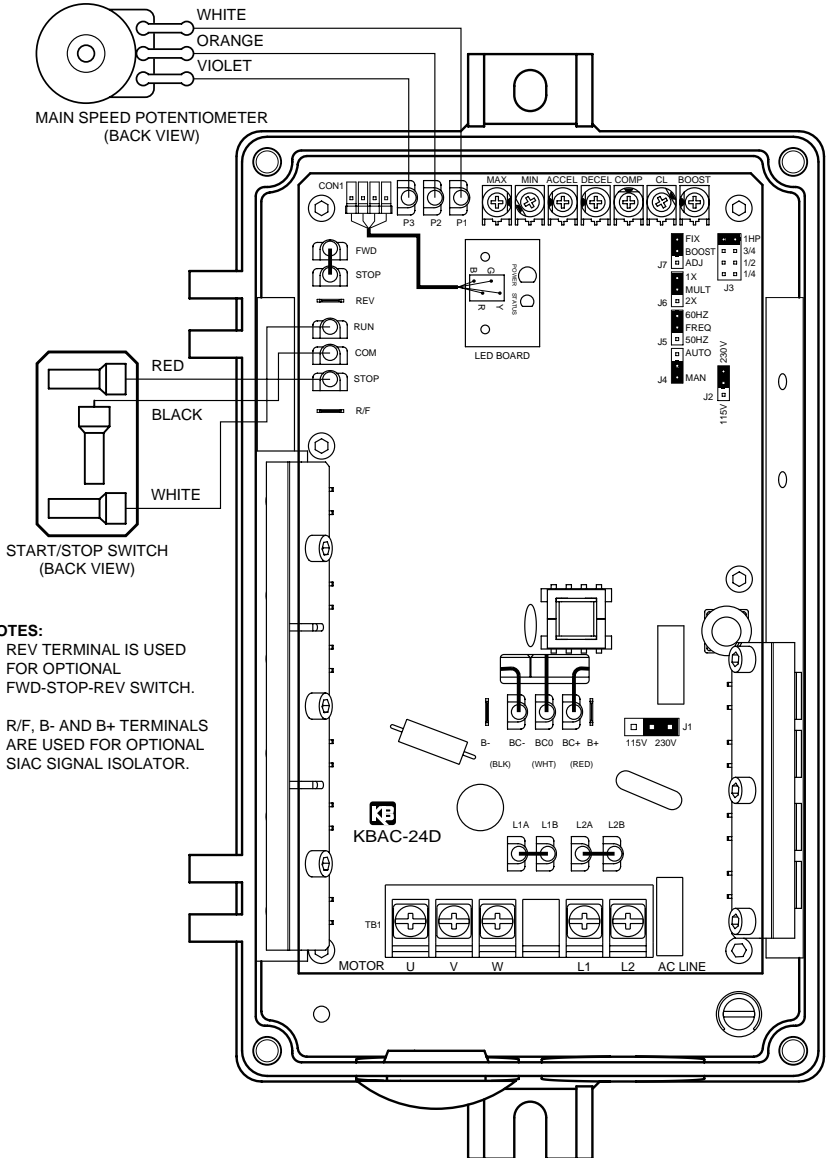

NOTES:

1. REV TERMINAL IS USED FOR OPTIONAL FWD-STOP-REV SWITCH.
2. R/F, B- AND B+ TERMINALS ARE USED FOR OPTIONAL SIAC SIGNAL ISOLATOR.

FIGURE 2 – ENLARGED VIEW OF TRIMPOT SETTINGS

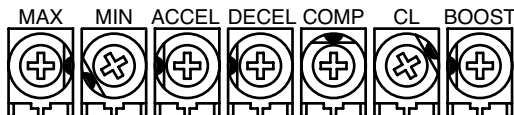
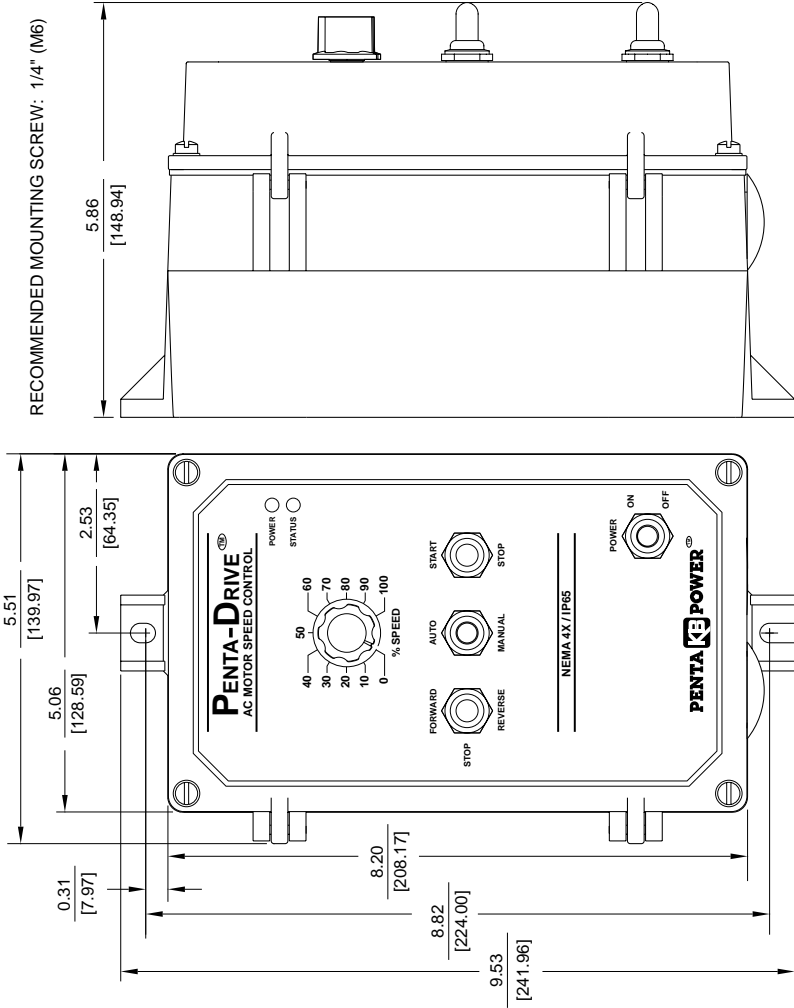

FIGURE 3 – MECHANICAL SPECIFICATIONS (Inches / [mm])



KBAC-24D SHOWN WITH OPTIONAL AUTO/MANUAL,
 FORWARD-STOP-REVERSE AND POWER ON/OFF SWITCHES

TABLE 2 – GENERAL PERFORMANCE SPECIFICATIONS

| Parameter | Specification | Factory Setting |
|--|------------------|-----------------|
| AC Line Input Voltage (Volts AC, $\pm 10\%$, 50/60 Hz) | 115 or 208/230 | 208/230 |
| Maximum Load Capacity (% for 2 Minutes) | 150 | — |
| Switching Frequency at Motor (kHz) | 16 | — |
| Signal Following (Non-Isolated Input ¹) Input Voltage (Volts DC) | 0 – 5 | — |
| Signal Following Input Resolution (Bits) | 8 | — |
| Maximum Speed Trimpot (MAX) Range (% of Frequency Setting) | 70 – 110 | 100 |
| Minimum Speed Trimpot (MIN) Range (% of Frequency Setting) | 0 – 40 | 0 |
| Acceleration Trimpot (ACCEL) Range (Seconds) | 0.3 – 20 | 1.5 |
| Deceleration Trimpot (DECEL) Range (Seconds) | 0.3 – 20 | 1.5 |
| Slip Compensation Trimpot (COMP) Range (Volts/Hz/Amp) | 0 – 3 | 1.5 |
| Current Limit Trimpot (CL) Range (% Range Setting) | 0 – 200 | 160 |
| Boost Trimpot (BOOST) Range for 50 Hz Output Frequency (Volts AC) | 0 – 70 | — |
| Boost Trimpot (BOOST) Range for 60 Hz Output Frequency (Volts AC) | 0 – 35 | 5 |
| Motor Horsepower Selection (HP) | 1/4, 1/2, 3/4, 1 | 1 |
| Output Frequency (Hz) | 0 – 50, 0 – 60 | 0 – 60 |
| Frequency Multiplier (1X, 2X) | 1, 2 | 1 |
| Minimum Operating Frequency at Motor (Hz) | 1 | — |
| Speed Regulation (30:1 Speed Range) (% Base Speed) ² | 2.5 | — |
| Speed Range (Ratio) | 60:1 | — |
| Operating Temperature Range (°C) | 0 – 45 | — |

Notes: 1. Requires an isolated signal. If a non-isolated signal voltage is used, install the SIAC Signal Isolator (P/N 9488).
2. Dependent on motor performance.

II. WIRING INSTRUCTIONS



WARNING! Read Safety Warning, on page 2, before using this control. Disconnect the AC line before wiring.

Note: To avoid erratic operation, do not bundle AC line and motor wires with wires from signal following, Start/Stop Switch or any other signal wires. Use shielded cables on all signal wiring over 12" (30cm). Shield should be Earth grounded on the control side only. Wire the control in accordance with the National Electrical Code requirements and other codes that may apply to your area. See Table 3 and Figure 4, on page 7.

Be sure to properly fuse each AC line conductor that is not at ground potential. **Do not fuse neutral or grounded conductors.** See Section VII, on page 11. A separate AC line switch or contactor must be wired as a disconnect so that each ungrounded conductor is opened. An accessory Power On/Off Switch (P/N 9482) may be used in lieu of, or in addition to, the Start/Stop Switch. The switch can be wired for single pole or double pole operation, as required.

To maintain the watertight integrity of the control, be sure to use suitable watertight connectors and wiring which are appropriate for the application. Two 7/8" (22.2mm) knockout holes are provided for standard 1/2" knockout connectors (not supplied) for wiring. A watertight plug is provided if only one knockout is required.

The KBAC-24D is designed with a hinged case so that when the front cover is open, all wiring stays intact. To open the cover, the four screws must be loosened so they are no longer engaged in the case bottom. After mounting and wiring, close the cover making sure that the wires do not get caught or crimped as the cover is closed. Tighten all four cover screws so that the gasket is slightly compressed. **Do not over tighten.**

TABLE 3 – TERMINAL BLOCK WIRING INFORMATION

| Designation | Connection | Supply Wire Gauge (AWG - Cu) | | Maximum Tightening Torque (in-lbs) |
|---------------|------------|------------------------------|---------|------------------------------------|
| | | Minimum | Maximum | |
| AC Line Input | L1, L2 | 22 | 12 | 12 |
| Motor | U, V, W | 22 | 12 | 12 |

A. AC Line Connection – Wire the AC line input to L1 and L2 terminals of Terminal Block TB1 as shown in Figure 4. Be sure **both** Jumpers J1 and J2 are set to the “115V” position for 115 Volt AC line input or to the “230V” position for 208/230 Volt AC line input.

FIGURE 4 – POWER CONNECTIONS

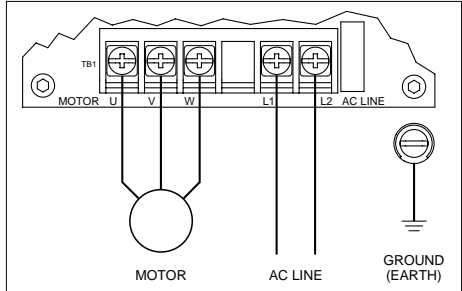

B. Ground Connection – Earth ground the control chassis using the green control screw that is provided on the inside of the control to the right side of Terminal Block TB1 as shown in Figure 4.

C. Motor Connection – Wire the motor leads to U, V and W terminals of Terminal Block TB1 as shown in Figure 4. Be sure Jumper J3 is set to the corresponding motor horsepower rating.

FIGURE 5 – REMOTE MAIN SPEED POTENTIOMETER CONNECTION

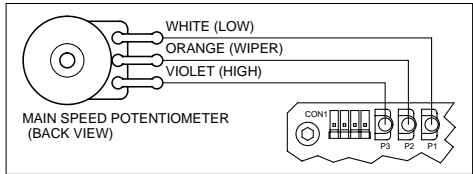

D. Remote Main Speed Potentiometer Connection – The control is supplied with a prewired Main Speed Potentiometer mounted on the front cover. To operate the control from a remote potentiometer (5kΩ), remove the white, orange, and violet potentiometer leads from P1, P2 and P3 terminals. The leads may be taped and left inside the control.

FIGURE 6 – REMOTE START/STOP SWITCH CONNECTION

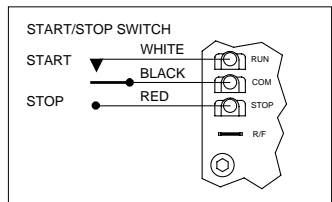

The potentiometer assembly may be removed if a watertight seal is used to cover the hole in the front cover. Connect the remote main speed potentiometer wires to P1 (low side), P2 (wiper) and P3 (high side) terminals as shown in Figure 5.

E. Remote Start/Stop Switch Connections – The control is supplied with a prewired Start/Stop switch, mounted on the front cover. To operate the control from a remote Start/Stop Switch (type (ON)-OFF-ON, SPDT), remove the white, black and red wires from RUN, COM and STOP terminals. The leads may be taped and left in the control. The switch assembly may be removed if a watertight seal is used to cover the hole in the front cover. Connect the remote Start/Stop Switch wires to RUN (momentary), COM (common) and STOP (constant) terminals as shown in Figure 6. After applying power, momentarily set the Start/Stop Switch to the "START" position. The motor will operate at the set speed of the Main Speed Potentiometer. To stop the motor, set the Start/Stop Switch to the "STOP" position.

FIGURE 7 – START/STOP FUNCTION ELIMINATED (JUMPER INSTALLED)

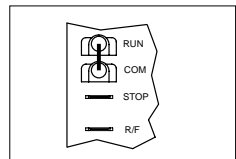

Note: To eliminate the Start/Stop function, connect RUN and COM terminals with the jumper that is provided. See Figure 7, on page 7.

CAUTION! Using a jumper to eliminate the Start/Stop function will cause the motor to run at the Main Speed Potentiometer setting when the AC line is applied.

- F. **Voltage Following Connection** – An isolated 0 - 5 Volt DC analog signal can also be used to control motor speed. See Figure 8.

FIGURE 8 – VOLTAGE FOLLOWING CONNECTION

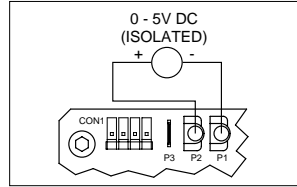

Note: If an isolated signal voltage is not available, an optional signal isolator can be installed (SIAC, P/N 9488). Connect the isolated signal voltage to P2 (+) and P1 (-) terminals. The MIN trimpot must be set fully counterclockwise.

- G. **Enable Circuit Connection** – The control can also be started and stopped with an Enable circuit (close to start). See Figure 9. The Enable function is established by wiring a switch in series with the orange Main Speed Potentiometer lead which connects to P2 terminal. When the Enable switch is closed, the control will accelerate to the Main Speed Potentiometer setting. When the Enable switch is opened, the motor will coast to stop.

FIGURE 9 – ENABLE CIRCUIT CONNECTION

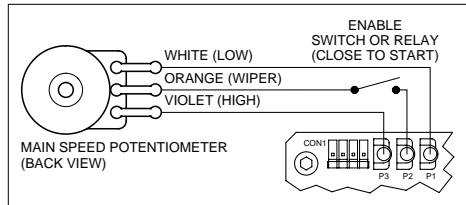

III. SETTING SELECTABLE JUMPERS

The KBAC-24D has customer selectable jumpers which must be set before the control can be used. See Figure 1, on page 4, for location of jumpers.

Note: Disconnect the AC line before changing position of jumpers.

- A. **AC Line Voltage Selection (J1 and J2)** – Jumpers J1 and J2 are **both** factory set to the “230V” position, for 208/230 Volt AC line input. For 115 Volt AC line input, set **both** Jumpers J1 and J2 to the “115V” position. See Figure 10.

FIGURE 10 – AC LINE INPUT VOLTAGE SELECTION

| Control Set for 208/230 Volt AC Line Input (Factory Setting) | | Control Set for 115 Volt AC Line Input | |
|--|---------------------------------------|--|-----------------------------------|
| J1 Set for 208/230 Volt AC Line Input | J2 Set for 208/230 Volt AC Line Input | J1 Set for 115 Volt AC Line Input | J2 Set for 115 Volt AC Line Input |
| | | | |

- B. **Motor Horsepower Selection (J3)** – Jumper J3 is factory set to the “1HP” position, for 1HP motors. For motors of lower horsepower, set Jumper J3 to the corresponding position for the motor being used. See Figure 11.

FIGURE 11 – MOTOR HORSEPOWER SELECTION

| J3 Set for 1 HP Motor (Factory Setting) | Motor Horsepower HP, (kW) |
|---|---------------------------|
| | 1, (0.75) |
| | 3/4, (0.5) |
| | 1/2, (0.37) |
| | 1/4, (0.18) |

- C. **Reset Mode Selection (J4)** – Jumper J4 is factory set to the “MAN” position, for manual resetting of the control every time the AC line is applied or after a fault condition has occurred (undervoltage, overvoltage, phase-to-phase short circuit and I²t

fault). To set the control to automatically reset after a fault has been cleared, set Jumper J3 to the "AUTO" position. See Figure 12. (Also see section VIB, on page 10 and Table 4, on page 11.)

WARNING! The motor will automatically restart when the AC line is applied, if Jumper J4 is set to the "AUTO" or "MAN" position and the Start/Stop Switch is eliminated with a jumper installed between the RUN and COM terminals.

D. Motor Frequency Selection (J5) – Jumper J5 is factory set to the "60Hz" position, for 60 Hz motors. For 50 Hz motors, set Jumper J5 to the "50Hz" position. See Figure 13.

E. Motor Frequency Multiplier Selection (J6) – Jumper J6 is factory set to the "1X" position, for motor frequency corresponding to the frequency setting of Jumper J5 (50 or 60 Hz). To double the output frequency to the motor, set Jumper J6 to the "2X" position (100 or 120 Hz). See Figure 14.

Note: When doubling the motor frequency, the motor will produce full torque up to its rated speed. The torque will be linearly reduced to 50% at the maximum doubled frequency.

F. Boost Mode Selection (J7): Jumper J7 is factory set to the "FIX" position, for fixed boost voltage. For adjustable boost voltage, using the BOOST trimpot, set Jumper J7 to the "ADJ" position. See Figure 15. (See section VIIG, on page 13).

IV. MOUNTING INSTRUCTIONS

WARNING! The KBAC-24D is not designed to be used in an explosion-proof application.

It is recommended that the control be mounted vertically on a flat surface with adequate ventilation. Leave enough room below the control to allow for AC line, motor connections and any other wiring. Although the control is designed for outdoor and wash down use, care should be taken to avoid extreme hazardous locations where physical damage can occur. If the control is mounted in a closed, unventilated location, allow enough room for proper heat dissipation. If operating the control at full rating, a minimum enclosure size of 12"W X 24"H X 12"D is required. See Figure 3, on page 5.

V. RECOMMENDED HIGH VOLTAGE DIELECTRIC WITHSTAND TESTING (HI-POT)

Testing agencies such as UL, CSA, VDE, etc., usually require that equipment undergo a hi-pot test. In order to prevent catastrophic damage to the speed control, which has been installed in the equipment, it is recommended that the following procedure be followed. Figure 16, on page 10 shows a typical hi-pot test setup.

Note: All equipment AC line inputs must be disconnected from the AC power.

A. Connect all equipment AC power input lines together and connect them to the H.V. lead of the hi-pot tester. Connect the RETURN lead of the hi-pot tester to the frame on which the control and other auxiliary equipment are mounted.

FIGURE 12 – RESTART MODE SELECTION

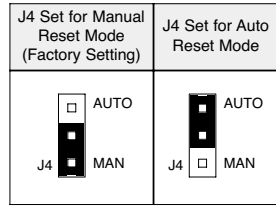

FIGURE 13 – MOTOR FREQUENCY SELECTION

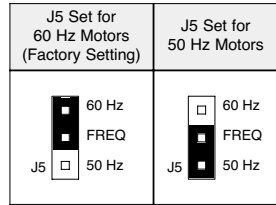

FIGURE 14 MOTOR FREQUENCY MULTIPLIER SELECTION

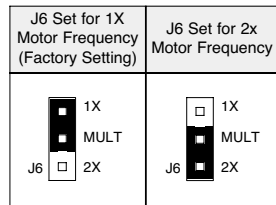
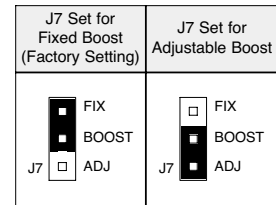

FIGURE 15 BOOST MODE SELECTION



- B. The hi-pot tester must have an automatic ramp-up to the test voltage and an automatic ramp-down to zero voltage.

Note: If the hi-pot tester does not have automatic ramping, then the hi-pot output must be manually increased to the test voltage and then manually reduced to zero. This procedure must be followed for each machine to be tested. A suggested hi-pot tester is Slaughter Model 2550.

WARNING! Instantaneously applying the hi-pot voltage will cause irreversible damage to the speed control.

- C. The hi-pot test voltage should be set in accordance to the testing agency standards and the leakage current should be set as low as possible without causing nuisance trips.
- D. To eliminate motor speed control damage due to auxiliary equipment hi-pot failure, it is also recommended that all signal inputs be wired together and connected to the AC input lines as shown.

FIGURE 16 – HI-POT SETUP

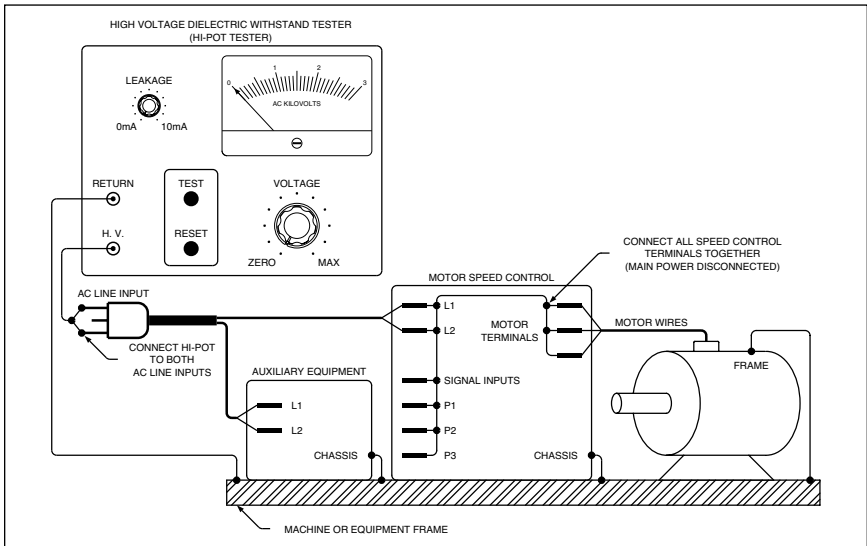

VI. CONTROL OPERATION

- A. **Start-Up Procedure** – After the control has been properly setup (jumpers and trim pots set to desired positions and wiring completed), the startup procedure can begin. If the AC power has been properly brought to the control, the POWER LED will be illuminated green. The STATUS LED will indicate control status as described in Section IX, on page 14. To start the control, momentarily set the Start/Stop Switch to the "START" position. The motor will begin to accelerate to the set speed.

Note: If the motor rotates in the incorrect direction, it will be necessary to disconnect the AC line, reverse any two motor leads, and repeat the startup procedure.

- B. **Fault Recovery** – The control has four fault states – undervoltage, overvoltage, short circuit at the motor (phase-to-phase) and I²t overload protection. To recover from any fault, it is necessary to momentarily set the Start/Stop Switch to the "START" position.

If the Start/Stop function has been eliminated by installing a jumper between RUN and COM terminals, then it will be necessary to either disconnect the AC line until the STATUS LED indicates an undervoltage fault (approximately 20 seconds) or use the Start/Stop Switch (if installed).

TABLE 4 – FAULT RECOVERY & RESETTING THE CONTROL*

| Fault | Auto Mode with Start/Stop Switch Installed | Manual Mode with Start/Stop Switch Installed | Auto or Manual Mode with Start/stop Switch Removed |
|---------------|---|---|--|
| Undervoltage | Control will automatically reset. | Reset the control with the Start/Stop Switch. | Control will automatically reset. |
| Overvoltage | Control will automatically reset. | Reset the control with the Start/Stop Switch. | Control will automatically reset. |
| Short Circuit | Control will automatically reset. | Reset the control with the Start/Stop Switch. | Control will automatically reset. |
| Pt | Reset the control with the Start/Stop Switch. | Reset the control with the Start/Stop Switch. | Disconnect and reconnect the AC line. |

*Fault must be cleared before the control can be reset.



WARNING! The motor will automatically start when the AC line is applied or a fault is cleared, if Jumper J4 is set to the “AUTO” or “MAN” position and the Start/Stop Switch is eliminated.

VII. AC LINE FUSING

This control does not contain AC line fuses. Most electrical codes require that each ungrounded conductor contain circuit protection. It is recommended to install a 20 Amp fuse (Littelfuse 326, Buss ABC or equivalent) or a circuit breaker in series with each ungrounded conductor. Check all electrical codes that apply to the application. **Do not fuse motor leads.**

VIII. TRIMPOT ADJUSTMENTS

The KBAC-24D contains trimpots, which are factory set for most applications. Figure 2, on page 4 illustrates the location of the trimpots and their approximate factory calibrated positions. Some applications may require readjustment of the trimpots in order to tailor the control for a specific requirement. Readjust trimpots as described below.



WARNING! If possible, do not adjust trimpots with the main power applied. If adjustments are made with the main power applied, an insulated adjustment tool must be used and safety glasses must be worn. High voltage exists in this control. Fire and/or electrocution can result if caution is not exercised. Safety Warning, on page 2, must be read before proceeding.

- A. Maximum Speed (MAX):** Sets the maximum speed of the motor. The MAX trimpot is factory set for 100% of base motor speed. For a higher maximum speed setting, rotate the MAX trimpot clockwise. For a lower maximum speed setting, rotate the MAX trimpot counterclockwise. See Figure 17.
- B. Minimum Speed (MIN):** Sets the minimum speed of the motor. The MIN trimpot is factory set for 0% speed. For a higher minimum speed setting, rotate the MIN trimpot clockwise. See Figure 18.
- C. Acceleration (ACCEL):** Sets the amount of time for the motor to accelerate from zero speed to full speed. The ACCEL trimpot is factory set for 1.5 seconds acceleration. For more rapid acceleration time, rotate the ACCEL trimpot counterclockwise. For longer acceleration time, rotate the ACCEL trimpot clockwise. See Figure 19.

Note: Rapid acceleration settings may cause the current limit circuit to activate, which will extend the acceleration time.

- D. Deceleration (DECEL):** Sets the amount of time for the motor to decelerate from full speed to zero speed. The DECEL trimpot is factory set for 1.5 seconds deceleration. For

**FIGURE 17
MAX TRIMPOT RANGE**

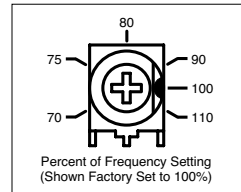

**FIGURE 18
MIN TRIMPOT RANGE**

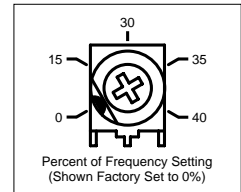

**FIGURE 19
ACCEL TRIMPOT RANGE**

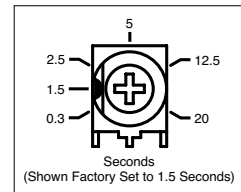

more rapid deceleration time, rotate the DECEL trimpot counterclockwise. For longer deceleration time, rotate the DECEL trimpot clockwise. See Figure 20.

Note: To provide increased resolution of the ACCEL and DECEL trimpots, 50% rotation covers 0.3 - 5 seconds.

Application Note: On applications with high inertial loads, the deceleration may automatically increase in time. This will slow down the rate of speed decrease to prevent the bus voltage from rising to the overvoltage trip point. This function is called regeneration protection. **It is recommended that for very high inertial loads that both the ACCEL and DECEL trimpots should not be set to less than ten (10) seconds.**

**FIGURE 20
DECEL TRIMPOT RANGE**

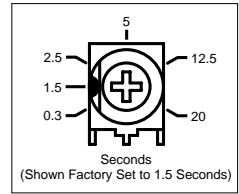

**FIGURE 21
COMP TRIMPOT RANGE**

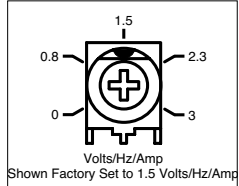

E. Slip Compensation (COMP) – Sets the amount of Volts/Hz/Amp to maintain set motor speed under varying loads. The COMP trimpot is factory set for 1.5 Volts/Hz/Amp. The slip compensation may be adjusted by the COMP trimpot as described below. See Figure 21.

1. Wire an ammeter in series with one motor phase.
2. Run the motor and set the unloaded speed to approximately 50%.
3. Load the motor to the rated motor nameplate current (Amps AC).
4. Adjust the COMP trimpot so that the loaded RPM is equal to the unloaded RPM.
5. The motor is now compensated to provide constant speed under varying loads.

F. Current Limit with I^t Shutdown (CL) – Sets the current limit (overload), which limits the maximum current to the motor. The current limit set point is established by the setting of Jumper J3 and the setting of the CL trimpot. See Figure 22.

**FIGURE 22
CL TRIMPOT RANGE**

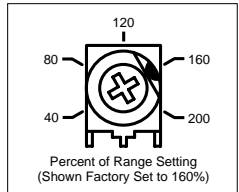
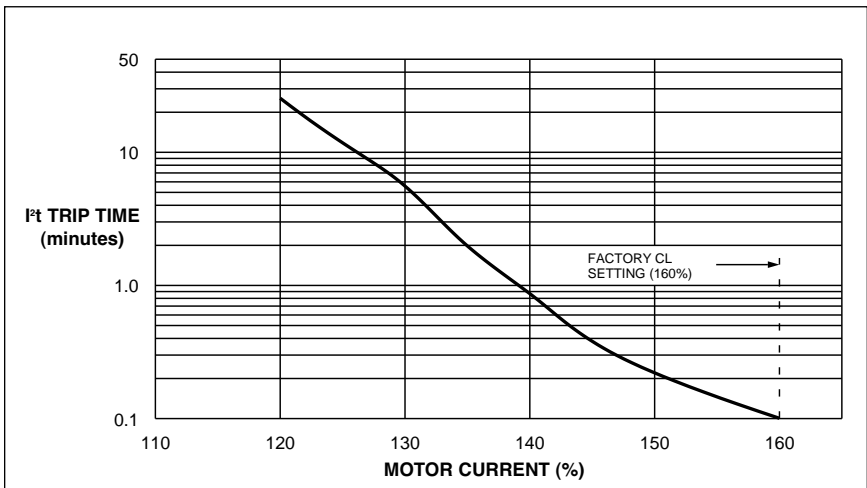

FIGURE 23 – I^t TRIP TIME vs MOTOR CURRENT



- NOTES:**
1. The CL set point is factory set to 160% of nominal motor current.
 2. I^t Will not trip below 120% of the CL setting.

The CL trimpot is factory set for 160% of Jumper J3 range setting. For a higher current limit setting, rotate the CL trimpot clockwise. For a lower current limit setting, rotate the CL trimpot counterclockwise. The current limit also contains I_t trip function. The control will trip according to a predetermined current vs. time function. The trip curve is directly related to the CL set point and can be changed with the CL trimpot. See Figure 23 on page 12.

CAUTION! Adjusting the CL above 160% of the motor rating can cause overheating of the motor. Consult the motor manufacturer. Do not leave the motor in a locked rotor condition for more than a few seconds since motor damage may occur.

G. Boost (BOOST) – Sets the amount of boost voltage to the motor. Jumper J7 is factory set to the "FIX" position, which provides a predefined amount of boost voltage for 50 Hz and 60 Hz motors. To adjust the amount of boost voltage to the motor, set Jumper J7 to the "ADJ" position. The amount of boost voltage may be adjusted by the BOOST trimpot as described below. See Figure 24.

**FIGURE 24
BOOST TRIMPOT RANGE**

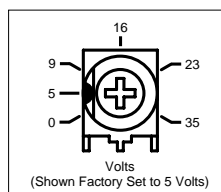

1. Connect an analog AC ammeter in series with one of the motor leads.

Note: Generally, digital or clamp-on ammeters do not yield accurate readings.

2. Run the motor **unloaded** at approximately 4 Hz (or 120 RPM).

Note: An unloaded motor with excessive boost will draw more current than a partially loaded motor.

3. Adjust the BOOST trimpot until the ammeter reading reaches the motor nameplate rating.
4. Using the Main Speed Potentiometer, slowly adjust the motor speed over a 0 - 15 Hz (0 - 450 RPM) range. If the motor current exceeds the nameplate rating, lower the boost setting.

WARNING! TO AVOID MOTOR WINDING OVERHEATING AND FAILURE, DO NOT OVERBOOST THE MOTOR.

TABLE 5 – CONTROL MODE AND STATUS LED INDICATION

| Control Mode | Status LED Information | | |
|-------------------------------------|------------------------|----------------------------------|--|
| | Flash Rate | Color Sequence | Illumination Duration Seconds |
| Run | Slow Flash | Green | 1 Sec On - 1 Sec Off |
| Stop | Steady | Yellow | Constant |
| Stand-By ¹ | Slow Flash | Yellow | 1 Sec On - 1 Sec Off |
| Short Circuit | Slow Flash | Red | 1 Sec On - 1 Sec Off |
| I _t Fault | Quick Flash | Red | 0.25 Sec On - 0.25 Sec Off |
| Overload | Steady | Red | Constant |
| Undervoltage | Quick Flash | Red - Yellow | 0.25 Sec Red - 0.25 Sec Yellow |
| Overvoltage | Slow Flash | Red - Yellow | 1 Sec Red - 1 Sec Yellow |
| Recovered Undervoltage ² | Quick Flash | Red - Yellow - Off - Green - Off | 0.25 Sec Red - 0.25 Sec Yellow - 0.5 Sec Off - 1 Sec Green - 0.5 Sec Off |
| Recovered Overvoltage ² | Slow Flash | Red - Yellow - Off - Green - Off | 1 Sec Red - 1 Sec Yellow - 0.5 Sec Off - 1 Sec Green - 0.5 Sec Off |

Notes: 1. Only if the Forward-Stop-Reverse Switch is installed

2. Only if the control is in Manual Reset Mode (Jumper J4 set to the "MAN" position).

IX. DIAGNOSTIC LEDs

The KBAC-24D is designed with LEDs mounted on the front cover to display the control's operational status.

A. Power On (ON) – Indicates the presence of bus voltage.

B. Status (STATUS) – The Status LED is a tricolor LED that provides indication of the control's operational status including installation problems such as incorrect input voltage, overvoltage, undervoltage and control miswiring. It also provides a "normal" indication if all control and microcontroller operating parameters are proper. See Table 5 on page 13.

X. OPTIONAL ACCESSORIES

Complete instructions and connection diagrams are supplied with all accessories to facilitate installation.

A. Forward-Stop-Reverse Switch (P/N 9480) – Provides motor reversing and stop functions. Mounts on the enclosure cover and is supplied with a switch seal to maintain watertight integrity.

B. Power On/Off Switch (P/N 9482) – Disconnects the AC line. Mounts on the enclosure cover and is supplied with a switch seal to maintain watertight integrity.

C. Signal Isolator/Run Relay SIAC (P/N 9488): Provides isolation between a non-isolated signal voltage source and the KBAC-24D and contains a Run Relay which can be used to turn on or off equipment or to signal a warning if the control is put into the Stop Mode or a fault has occurred.

D. Auto/Manual Switch (P/N 9481) – When used with the SIAC, it either selects an isolated signal from the SIAC or the Main Speed Potentiometer. Mounts on the enclosure cover and is supplied with a switch seal to maintain watertight integrity.

E. Multi Speed Board (P/N 9489) – Provides multi speed operation through a PLC. (Available Spring 2001.)

XI. LIMITED WARRANTY

For a period of 18 months from the date of original purchase, KB Electronics, Inc. will repair or replace, without charge, devices which our examination proves to be defective in material or workmanship. This warranty is valid if the unit has not been tampered with by unauthorized persons, misused, abused, or improperly installed and has been used in accordance with the instructions and/or ratings supplied. The foregoing is in lieu of any other warranty or guarantee, expressed or implied. KB Electronics, Inc. is not responsible for any expense, including installation and removal, inconvenience, or consequential damage, including injury to any person, caused by items of our manufacture or sale. Some states do not allow certain exclusions or limitations found in this warranty and therefore they may not apply to you. In any event, the total liability of KB Electronics, Inc., under any circumstance, shall not exceed the full purchase price of this product. (rev 2/2000)



KB Electronics, Inc.

12095 NW 39th Street, Coral Springs, FL 33065-2516 • (954) 346-4900 • Fax (954) 346-3377
Outside Florida Call TOLL FREE (800) 221-6570 • E-mail – info@kbelectronics.com
www.kbelectronics.com