

INSTALLATION AND OPERATING INSTRUCTIONS

MODEL KBRC-240D

FULL-WAVE 4-QUADRANT REGENERATIVE DRIVE

NEMA 4X, IP-65

KB Part No. 8840 (Black Case) • Part No. 8841 (White Case)

Rated for 1/10 - 1 HP (90 Volts DC) @ 115 Volts AC, 50/60 Hz
and 1/5 - 2 HP (180 Volts DC) @ 208/230 Volts AC, 50/60 Hz

Washdown and Watertight for Indoor and Outdoor Use

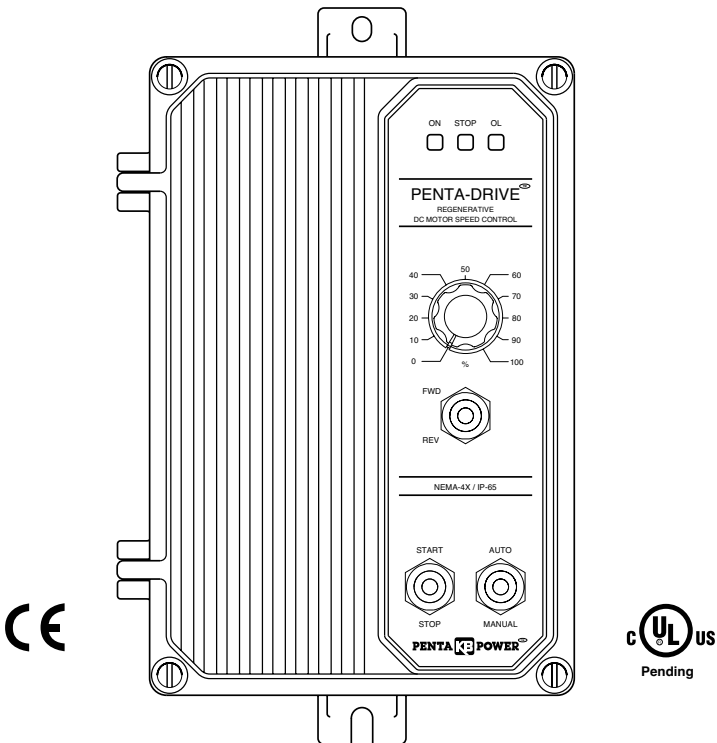

See Safety Warning on Page 5

The information contained in this manual is intended to be accurate. However, the manufacturer retains the right to make changes in design which may not be included herein.

PENTA KB POWER[™]

A COMPLETE LINE OF MOTOR DRIVES

© 2000 KB Electronics, Inc.

TABLE OF CONTENTS

Section	Page
i. Simplified Operating Instructions	4
ii. Safety Warning	5
I. Introduction	5
II. Wiring Instructions	9
III. Setting Selectable Jumpers	14
IV. Mounting Instructions	17
V. Recommended High Voltage Dielectric Withstand Testing (Hi-Pot Testing)	17
VI. Operation	18
VII. AC Line Fusing	18
VIII. Trimpot Adjustments	19
IX. Diagnostic LEDs	22
X. Optional Accessories	22
XI. Limited Warranty	24
 Tables	
1. General Performance Specifications	6
2. Electrical Ratings	6
3. Terminal Block Wiring Information	9
4. Field Connection (Shunt Wound Motors Only)	11
5. Run Relay Output Contacts	13
6. Setting Motor Current	15
7. Control Operation	18
 Figures	
1. Control Layout	7
2. Enlarged View of Trimpots	7
3. Mechanical Specifications	8
4. Power Connections	10
5. Full Voltage Field Connection (Shunt Wound Motors Only)	10
6. Half Voltage Field Connection (Shunt Wound Motors Only)	10
7. Unidirectional Forward Main Speed Potentiometer Connection	11
8. Unidirectional Reverse Main Speed Potentiometer Connection	11
9. Bidirectional Main Speed Potentiometer Connection	12
10. Bidirectional Main Speed Potentiometer Connection with Reversing Contacts	12
11. Remote Start/Stop Switch Connection	12
12. Start/Stop Function Eliminated (Jumper Installed)	12
13. Voltage Following Connection	13
14. Enable Circuit Connection	13

15. DC Tach-Generator Connection	14
16. DC Tach-Generator Connection with Addition of R_T	14
17. AC Line Input Voltage Selection (J1 and J2)	14
18. Motor Voltage Selection (J3)	14
19. DC Tach-Generator Voltage Selection (J3)	15
20. Motor Current Selection (J4)	15
21. Analog Input Signal Voltage Selection (J5)	15
22. Control Mode Selection (J6)	16
23. Torque Mode Selection (J7)	16
24. Current Limit Mode Selection (J8)	16
25. Stop Mode Selection (J9)	16
26. Run Relay Output Mode Selection (J10)	16
27. Enable Jumper (J11)	17
28. Hi-Pot Test Setup	17
29. Linear Torque Mode	18
30. Non-Linear Torque Mode	18
31. Offset (OFFSET) Trimpot Range	19
32. Offset (OFFSET) Trimpot Adjustment	19
33. Forward Acceleration (FACC) Trimpot Range	19
34. Reverse Acceleration (RACC) Trimpot Range	19
35. Forward Acceleration (FACC) and Reverse Acceleration (RACC) Trimpot Adjustment	19
36. Maximum Speed (MAX) Trimpot Range	20
37. Forward Current Limit (FWDCL) Trimpot Range	20
38. Reverse Acceleration (REVCL) Trimpot Range	20
39. IR Compensation (IR) Trimpot Range	20
40. Response (RESP) Trimpot Range	21
41. Deadband (DB) Trimpot Range	21
42. Deadband (DB) Trimpot Adjustment	21
43. Timed Current Limit (TCL) Trimpot Range	21

i. SIMPLIFIED OPERATING INSTRUCTIONS

IMPORTANT – You must read these simplified operating instructions before proceeding. These instructions are to be used as a reference only and are not intended to replace the detailed instructions provided herein. You must read the Safety Warning, on page 5, before proceeding.

A. Power Connection – Connect the AC line to L1 and L2 terminals of Terminal Block TB1 and the ground wire (earth) to the green ground screw, as shown in Figure 4, on page 10 and as described in Section IIA, on page 10 and Section IIB on page 10.

Be sure Jumpers J1 and J2 are **both** set to the corresponding AC line input voltage position, as described in Section IIIA, on page 14.

B. Permanent Magnet (PM) Motor Connection (Two Wire Type) – Connect the motor armature to M1 (+) and M2 (-) terminals of Terminal Block TB1, as shown in Figure 4, on page 10 and as described in Section IIC, on page 10. Be sure that Jumper J3 is set to the corresponding motor voltage position, as described in Section IIIB, on page 14 and Jumper J4 is set to the corresponding motor current, as described in Section IIID, on page 15.

Note: Do not use F+ and F- terminals of Terminal Block TB2 for any purpose other than to power the field of a shunt wound motor. Do not use F+ and F- terminals of Terminal Block TB2 for PM motors. Do not use F1 and F2 quick-connect terminals for any purpose other than to power the optional Signal Isolator SIRC (P/N 8842).

Note: Motor performance and efficiency, including brush life, may be adversely affected when operating the control in stepdown mode (208/230 Volt AC line with 90 Volt DC motors).

C. Shunt Wound Motors (Four Wire Type) – Connect the motor armature as described in Section IIC, on page 10.

Connect full voltage field wires (90 Volt DC motors with 100 Volt DC field and 180 Volt DC motors with 200 Volt DC field) to F+ and F- terminals of Terminal Block TB2, as described in Section IID, on page 10.

Connect half voltage field wires (90 Volt DC motors with 50 Volt DC field and 180 Volt DC motors with 100 Volt DC field) to F+ terminal of Terminal Block TB2 and L1 terminal of Terminal Block TB1, as described in Section IIE, on page 11.

Note: Do not connect motor armature leads to F+ and F- terminals of Terminal Block TB2 or to F1 and F2 quick-connect terminals. Do not use F1 and F2 quick-connect terminals for any purpose other than to power the optional Signal Isolator SIRC (P/N 8842).

D. Start/Stop Switch – The control is supplied with a prewired Start/Stop Switch, as described in Section IIG, on page 12. This switch must be used to start the control each time the AC power is lost or the control shuts down in TCL. To eliminate this function, see Section IIG, on page 12.

E. Motor Current – Jumper J4 is factory set for 10 Amp motors. For a lower current motor, set Jumper J4 to the corresponding motor current, as described in Section IIID, on page 15.

Note: The factory setting for Current Limit is 150% of the nominal current setting (example: if Jumper J4 is set to the “10A” position, the CL trimpot is calibrated for 15 Amps).

F. Trimpot Settings – All trimpots have been factory set, as shown in Figure 2, on page 7. Trimpots may be readjusted, as described in Section VIII, on page 19.

G. Diagnostic LEDs – After power has been applied, observe the LEDs to verify proper control function, as described in Section IX, on page 22.

ii.  **SAFETY WARNING! Please read carefully**

This product should be installed and serviced by a qualified technician, electrician, or electrical maintenance person familiar with its operation and the hazards involved. Proper installation, which includes wiring, mounting in proper enclosure, fusing or other over current protection, and grounding can reduce the chance of electrical shocks, fires, or explosion in this product or products used with this product, such as electric motors, switches, coils, solenoids, and/or relays. Eye protection must be worn and insulated adjustment tools must be used when working with control under power. This product is constructed of materials (plastics, metals, carbon, silicon, etc.) which may be a potential hazard. Proper shielding, grounding and filtering of this product can reduce the emission of radio frequency interference (RFI) which may adversely affect sensitive electronic equipment. If further information is required on this product, contact the Sales Department. It is the responsibility of the equipment manufacturer and individual installer to supply this Safety Warning to the ultimate end user of this product. (SW effective 9/2000).

This control contains electronic Start/Stop circuits that can be used to start and stop the control. However these circuits are never to be used as safety disconnects since they are not fail-safe. Use only the AC line for this purpose.

Be sure to follow all instructions carefully. Fire and/or electrocution can result due to improper use of this product.

 This product complies with all CE directives pertinent at the time of manufacture. Contact factory for detailed installation and Declaration of Conformity. Installation of a CE approved RFI filter (KBRF-200A [P/N 9945C] or equivalent) is required. Additional shielded motor cable and/or AC line cables may be required along with a signal isolator (SIRC [P/N 8842] or equivalent).

I. INTRODUCTION

Thank you for purchasing the KBRC-240D. KB Electronics, Inc. is committed to providing total customer satisfaction by producing quality products that are easy to install and operate. The KBRC-240D is manufactured with surface mount components incorporating advanced circuitry and technology.

The KBRC-240D is a Full-Wave Regenerative Drive in a NEMA-4X / IP-65 washdown and watertight enclosure. It is designed to operate 90 and 180 Volt Permanent Magnet and Shunt Wound DC motors in a bidirectional mode. It provides 4-quadrant operation, which allows forward and reverse torque in both speed directions. This allows the control to maintain constant speed with overhauling loads and provides rapid instant reversing and controlled braking. Because of its excellent performance, the control can replace servo drives in many applications.

The KBRC-240D has a Regeneration Overspeed Protection Circuit, which prevents failure of the power bridge in extreme overhauling conditions. Motor overload protection (I X t) will shut down the control if the motor is overloaded for a predetermined amount of time. The exclusive Auto-Inhibit[®] circuit allows safe, smooth starting during rapid cycling of the AC line.

Due to its user-friendly design, tailoring the KBRC-240D to specific applications is easily accomplished via selectable jumpers and adjustable trimpots. However, for most applications, no adjustments are necessary.

The KBRC-240D can be operated from a two or three wire start/stop circuit or can be started from the AC line. A set of dedicated normally open or normally closed relay contacts are provided (Run Relay), which are activated via the start/stop circuit. They can be used to turn on or off equipment or to signal a warning if the control is put into Stop Mode or times out in TCL.

The Main features of the KBRC-240D include Speed (SPD) or Torque (TRQ) control modes. In the Linear Torque mode (S/L), speed and torque vary linearly as a function of Main Speed

Potentiometer rotation or input signal. In the Non-Linear Torque mode (NL), the torque is varied by the Main Speed Potentiometer or input signal, and remains constant throughout the motor's entire speed range. In addition, Regenerate-to-Stop (RTS) or Coast-to-Stop (CTS) stop modes are also provided.

Standard front panel features of the KBRC-240D include diagnostic LEDs (for Power On, Stop and Overload), a Start/Stop Switch and a Main Speed Potentiometer. Other features include Barrier Terminal Blocks (facilitates wiring of the AC line, motor armature and field, tach-generator and run relay), adjustable trimpots (OFFSET, FACC, RACC, MAX, FWDCL, REVCL, IR, RESP, DB and TCL), selectable jumpers (AC line voltage, motor voltage or tach feedback, motor current, analog input voltage, control mode, torque mode, current limit mode, stopping mode, run relay output contacts and enable) and PC Board mounted LEDs (Power On, Overload, Forward Enable and Reverse Enable).

Optional accessories for the KBRC-240D include a Forward-Stop-Reverse Switch, Auto/Manual Switch, Power On/Off Switch and a Signal Isolator. Quick-connect terminals are provided for easy installation of all accessories. See Section X, on page 22.

TABLE 1 – GENERAL PERFORMANCE SPECIFICATIONS

Parameter	Specification	Factory Setting
AC Line Input Voltage (Volts AC, $\pm 10\%$, 50/60 Hz)	115 and 208/230	230
Armature Voltage Range at 115 Volts AC Line (Volts DC)	0 – ± 90	–
Armature Voltage Range at 208/230 Volts AC Line (Volts DC)	0 – $\pm 90^1$, 0 – ± 180	0 – ± 180
Field Voltage at 115 Volts AC Line (Volts DC)	100/50	–
Field Voltage at 208/230 Volts AC Line (Volts DC)	200/100	–
Signal Following Input (Non-Isolated ²) Range (Volts DC)	0 – ± 10 , 0 – ± 15	0 – ± 15
Signal Following Linearity (% Base Speed)	1	–
Line Regulation (% Base Speed)	± 0.5	–
Armature Feedback Load Regulation (% Base Speed)	± 1	–
Tach-Generator Feedback Load Regulation (% Set Speed)	± 1	–
Maximum Load Capacity (% for 2 Minutes)	150	–
Current Ranges (Amps DC)	1.7, 2.5, 5, 7.5, 10	10
Speed Range (Ratio)	50:1	–
Operating Temperature Range ($^{\circ}\text{C}$)	0 – 45	–
Offset Trimpot (OFFSET) Range (% Base Speed)	0 – ± 10	0
Reverse Acceleration Trimpot (RACC) Range (Seconds)	0.2 – 15	1
Forward Acceleration Trimpot (FACC) Range (Seconds)	0.2 – 15	1
Maximum Speed Trimpot (MAX) Range (% Base Speed)	70 – 110	100
Forward Current Limit Trimpot (FWDCL) Range (% Range Setting)	0 – 200	150
Reverse Current Limit Trimpot (REVCL) Range (% Range Setting)	0 – 200	150
IR Compensation Trimpot (IR) Range at 90 Volts DC Output (Volts DC at Full Load)	0 – 15	–
IR Compensation Trimpot (IR) Range at 180 Volts DC Output (Volts DC at Full Load)	0 – 30	10
Deadband Trimpot (DB) Range (% Base Speed)	0 – ± 3	0.5
Timed Current Limit Trimpot (TCL) Range (Seconds)	0 – 15	5

- Notes:** 1. Step-down operation: Motor may have reduced brush life. Consult motor manufacturer.
 2. Requires an isolated signal. If a non-isolated signal is used, install the Signal Isolator SIRC (P/N 8842).

TABLE 2 – ELECTRICAL RATINGS

AC Line Input Voltage ($\pm 10\%$, 50/60 Hz) (Single Phase Volts AC)	Maximum AC Line Input Current (Amps AC)	Nominal Output Voltage (Volts DC)	Maximum Output Load Current (Amps DC)	Maximum Horsepower Rating HP, (kW)
115	15	0 – ± 90	11	1, (0.75)
208/230	15	0 – ± 180	11	2, (1.5)
208/230	15	0 – $\pm 90^1$	11	1, (0.75)

- Note:** 1. Step-down operation: Motor may have reduced brush life. Consult motor manufacturer.

FIGURE 1 – CONTROL LAYOUT

(Illustrates Factory Setting of Jumpers and Approximate Trimpot Settings)

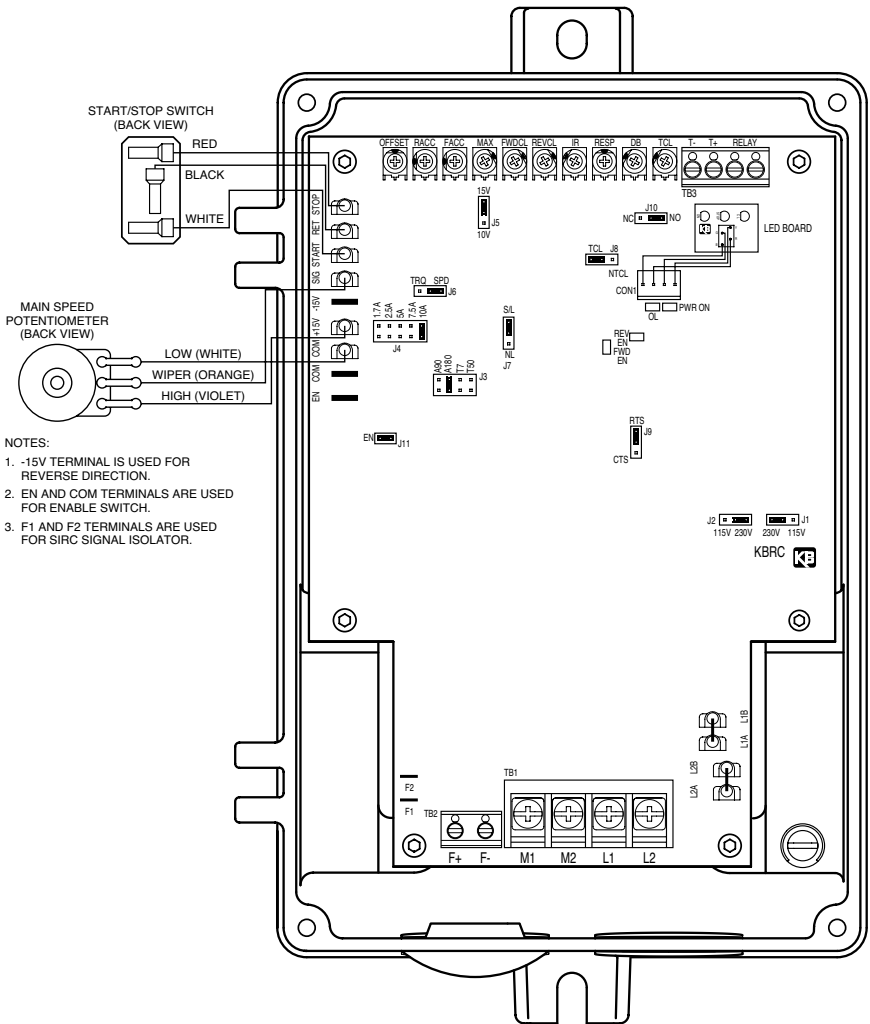

FIGURE 2 – ENLARGED VIEW OF TRIMPOTS

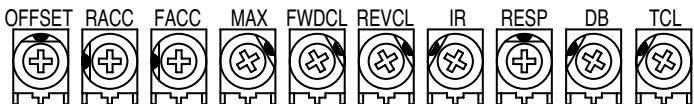
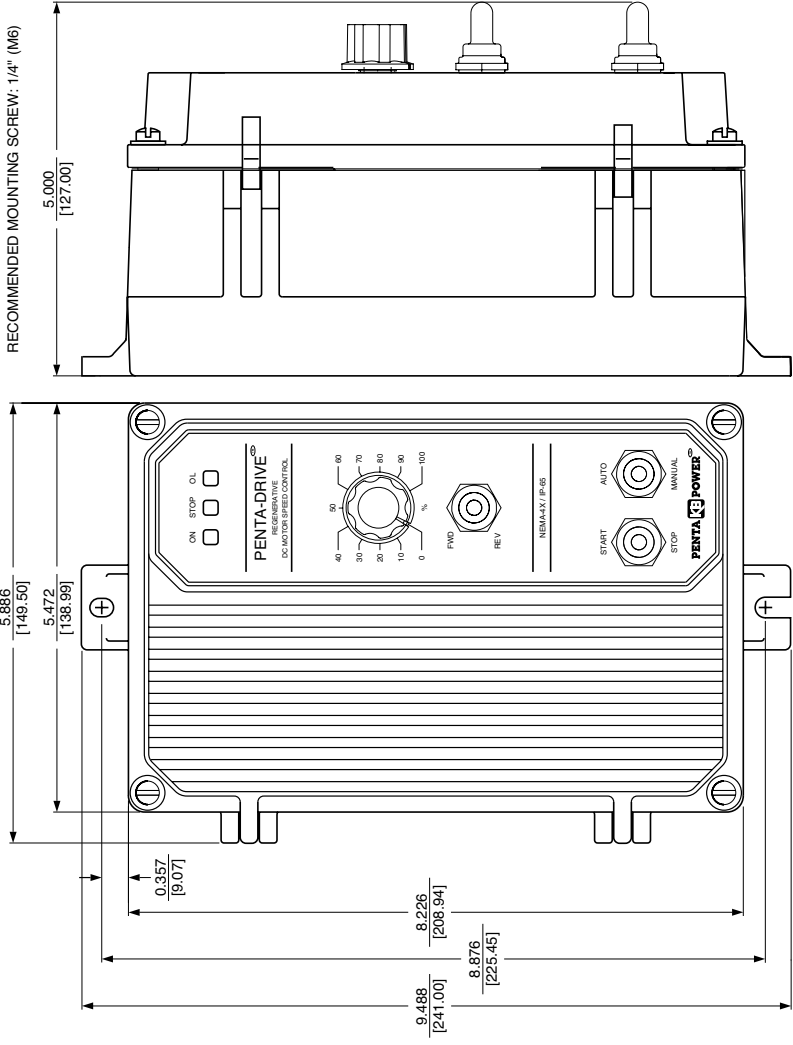

FIGURE 3 – MECHANICAL SPECIFICATIONS (Inches / [mm])



KBRC-240D SHOWN WITH OPTIONAL FORWARD-BRAKE-REVERSE AND AUTO/MANUAL SWITCHES

STANDARD FEATURES

- A. Short Circuit Protection** – Protects the control from a short circuit at motor connections.
- B. Electronic Motor Burnout Protection (I X t)** – Shuts down the control if a prolonged overload condition exists.
- C. Start/Stop Switch** – Provides electronic start/stop function.
- D. Diagnostic LEDs** – For power on (ON), stop (STOP) and motor overload (OL).
- E. Selectable Jumpers** – Provide settings for AC line input voltage (J1 and J2), armature voltage or tach-generator feedback (J3), motor current (J4), analog input voltage (J5), control mode (J6), torque mode (J7), current limit mode (J8), stopping mode (J9), run relay output contacts (J10) and enable (J11). See Section III, on page 14.
- F. Trimpots** – Provide adjustment for offset (OFFSET), forward acceleration (FACC), reverse acceleration (RACC), maximum speed (MAX), forward current limit (FWDCL), reverse current limit (REVCL), IR compensation (IR), response (RESP), deadband (DB) and timed current limit (TCL). See Section VIII, on page 19.
- G. Barrier Terminal Blocks** – Facilitate wiring of AC line, motor armature and field, tach-generator and run relay output.
- H. Quick-Connect Terminals** – Facilitate connecting the Forward-Stop-Reverse Switch, Power On/Off Switch, Start/Stop Switch, Auto/Manual Switch and Enable Switch.

II. WIRING INSTRUCTIONS



Warning! Read Safety Warning, on page 5, before using this control. Disconnect the AC line before wiring.

Note: To avoid erratic operation, do not bundle AC line and motor wires with wires from signal following, Start/Stop Switch, Enable, or any other signal wires. Use shielded cables on all signal wiring over 12" (30cm). The shield should be earth grounded on the control side only. Wire the control in accordance with the National Electrical Code requirements and other codes that may apply to your area. See Figure 4, on page 10, Table 3 and Table 4, on page 11.

Be sure to properly fuse each conductor that is not at ground potential. **Do not fuse neutral or grounded conductors.** See Section VII, on page 18. A separate AC line switch or contactor must be wired as a disconnect so that each ungrounded conductor is opened. An accessory Power On/Off Switch (P/N 9486) may be used in lieu of, or in addition to, the Start/Stop switch. The switch can be wired for single pole or double pole operation, as required.

To maintain the watertight integrity of the control, be sure to use suitable watertight connectors and wiring which are appropriate for the application. Two 7/8" (22.2mm) knockout holes are provided for standard 1/2" knockout connectors (not supplied) for wiring. A watertight plug is provided if only one knockout is required.

TABLE 3 – TERMINAL BLOCK WIRING INFORMATION

Terminal Block	Designation	Connections	Supply Wire Gauge (AWG-Cu)		Maximum Tightening Torque (in-lbs)
			Minimum	Maximum	
TB1	AC Line Input	L1 and L2	22	12	12
TB1	Motor Armature	M1 and M2	22	12	12
TB2	Motor Field (Shunt Wound Motors Only)	F1 and F2	24	14	3.5
TB3	Tach-Generator	T+ and T-	24	14	3.5
TB3	Run Relay	RELAY	24	14	3.5

Warning! Do not wire switches or relays in series with the armature. Armature switching can cause catastrophic failure of motor and/or control. To avoid erratic operation, do not bundle AC line and motor wires with potentiometer wires, voltage following wires, Start/Stop Switch wires, enable wires, or any other signal wires. Use shielded cables on all signal wiring over 12" (30cm) long. The shield should be earth grounded on the control side only.

The KBRC-240D is designed with a hinged case so that when the front cover is open, all wiring stays intact. To open the cover, the four screws must be loosened so they are no longer engaged in the case bottom. After mounting and wiring, close the cover and make sure that wires will not get caught or crimped as the cover is closed. Tighten all four cover screws so that the gasket is slightly compressed. **Do not over tighten.**

FIGURE 4 – POWER CONNECTIONS

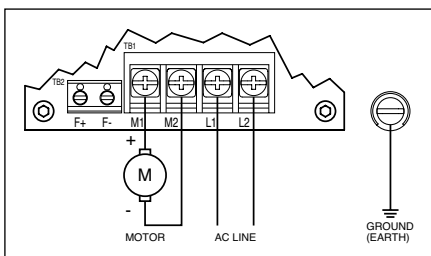

A. AC Line Connection – Wire the AC line to L1 and L2 terminals of Terminal Block TB1, as shown in Figure 4.

B. Ground Connection – Earth ground the control chassis using the green ground screw that is provided on the inside of the control to the right side of Terminal Block TB1, as shown in Figure 4.

C. Permanent Magnet (PM) Motor Connection – Wire the motor armature leads to M1 and M2 terminals of Terminal Block TB1, as shown in Figure 4. Be sure Jumper J3 is set to the corresponding motor voltage and Jumper J4 is set to the corresponding motor current.

For step-down operation (230 Volt AC line input with 90 Volt DC SCR rated motors) set Jumper J3 to the “90V” position. However, in step-down operation the motor may have reduced brush life - consult motor manufacturer. **Note:** If the motor runs in the opposite direction than is desired, disconnect power and reverse the motor leads.

Note: Do not connect motor armature leads to F+ and F- terminals of Terminal Block TB2 or to F1 and F2 quick-connect terminals. Do not use F1 and F2 quick-connect terminals for any purpose other than to power the optional Signal Isolator SIRC (P/N 8842).

FIGURE 5 – FULL VOLTAGE FIELD CONNECTION (Shunt Wound Motors Only)

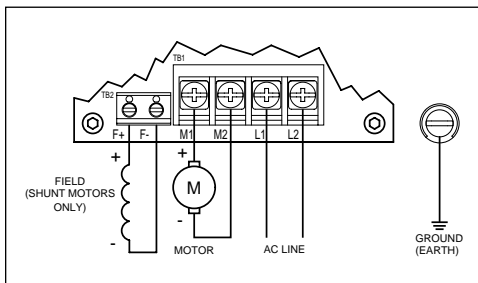
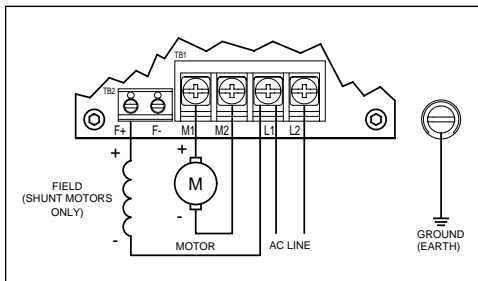

FIGURE 6 – HALF VOLTAGE FIELD CONNECTION (Shunt Wound Motors Only)



D. Full Voltage Field Connection (Shunt Wound Motors Only) – Wire the motor field leads to F+ and F- terminals of Terminal Block TB2, as shown in Figure 5 and as described in Table 4, on page 11.

Note: Do not connect motor armature leads to F1 and F2 quick-connect terminals. Do not use F+ and F- terminals of Terminal Block TB2 for any purpose other than to power the field of a shunt wound motor.

E. Half Voltage Field Connection (Shunt Wound Motors Only) – Wire the motor field leads to F+ terminal of Terminal Block TB2 and L1 terminal of Terminal Block TB1, as shown in Figure 6, on page 10 and as described in Table 4.

Note: Do not connect motor armature leads to F+ and F- terminal of Terminal Block TB2 or to F1 and F2 quick-connect terminals. Do not use F+ and F- terminals of Terminal Block TB2 for any purpose other than to power the field of a shunt wound motor.

TABLE 4 – FIELD CONNECTION (SHUNT WOUND MOTORS ONLY)

AC Line Voltage (Volts AC)	Armature Voltage (Volts DC)	Field Voltage (Volts DC)	Field Connections
115	0 – ±90	100	F+ and F-
115	0 – ±90	50	F+ and L1
208/230	0 – ±180	200	F+ and F-
208/230	0 – ±180	100	F+ and L1
208/230	0 – ±90	100	F+ and L1

F. Remote Main Speed Potentiometer Connection – The control is supplied with a prewired Main Speed Potentiometer mounted on the front cover for unidirectional forward operation of the motor as shown in Figure 7.

To rewire the Main Speed Potentiometer for a different direction or to operate the control from a remote potentiometer (5k), remove the white, orange and violet potentiometer leads from P1, P2 and P3 terminals and connect it as described below. The leads may be taped and left inside the control. The potentiometer assembly may be removed if a watertight seal is used to cover the hole in the front cover.

1. Unidirectional Forward

Operation – Connect the Main Speed Potentiometer high side to +15V terminal, wiper to SIG terminal and low side to COM terminal, as shown in Figure 7. Rotating the Main Speed Potentiometer clockwise will increase motor speed in the forward direction. Rotating the Main Speed Potentiometer counterclockwise will decrease motor speed. **Note:** Jumper J5 must be set to the “15V” position.

FIGURE 7 – UNIDIRECTIONAL FORWARD MAIN SPEED POTENTIOMETER CONNECTION

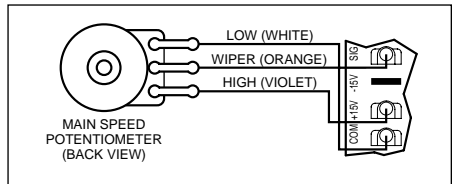

2. Unidirectional Reverse

Operation – Connect the Main Speed Potentiometer high side to -15V terminal, wiper to SIG terminal and low side to COM terminal, as shown in Figure 8. Rotating the Main Speed Potentiometer clockwise will increase motor speed in the reverse direction. Rotating the Main Speed Potentiometer counterclockwise will decrease motor speed. **Note:** Jumper J5 must be set to the “15V” position.

FIGURE 8 – UNIDIRECTIONAL REVERSE MAIN SPEED POTENTIOMETER CONNECTION

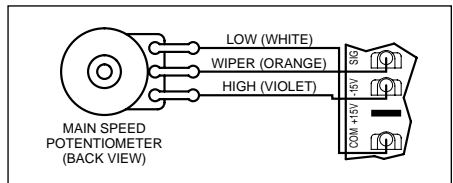

- 3. Bidirectional Operation –** Provides forward and reverse operation using the Main Speed Potentiometer. Connect the Main Speed Potentiometer high side to +15V terminal, wiper to SIG terminal and low side to -15V terminal, as shown in Figure 9. Zero motor speed will now be located at 50% rotation.

FIGURE 9 – BIDIRECTIONAL MAIN SPEED POTENTIOMETER CONNECTION

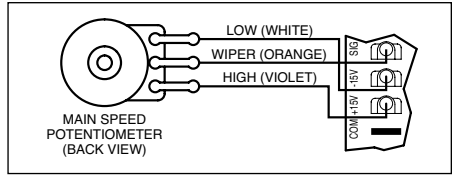

Rotating the Main Speed Potentiometer clockwise will increase motor speed in the forward direction. Rotating the Main Speed Potentiometer counterclockwise will increase motor speed in the reverse direction. **Note:** Jumper J5 must be set to the “15V” position.

Note: If the motor runs in the opposite direction than is desired, disconnect power and either reverse the high side and low side of the Main Speed Potentiometer wires or reverse the motor leads to M1 and M2 terminals of Terminal Block TB1.

- 4. Bidirectional Operation with Reversing Contacts –** Connect the Main Speed Potentiometer high side to the center of the switch (type ON-OFF-ON, SPDT switch with center off position), wiper to SIG terminal and low side to COM terminal. Connect the “forward” side of the switch to the +15V terminal and the “reverse”

FIGURE 10 – BIDIRECTIONAL MAIN SPEED POTENTIOMETER CONNECTION WITH REVERSING CONTACTS

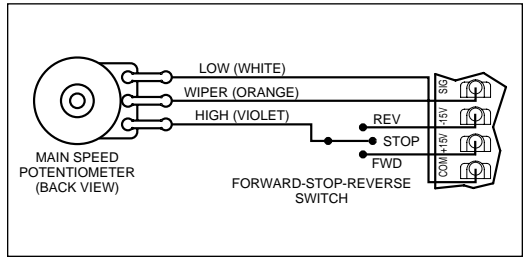

side of the switch to the -15V terminal, as shown in Figure 10. Rotating the Main Speed Potentiometer clockwise will increase motor speed in the direction selected by the switch. Rotating the Main Speed Potentiometer counterclockwise will decrease motor speed. **Note:** Jumper J5 must be set to the “15V” position.

- G. Remote Start/Stop Switch Connection –** The control is supplied with a prewired Start/Stop Switch, mounted on the front cover. To operate the control from a remote Start/Stop Switch (type (ON)-OFF-ON, SPDT), remove the white, black, and red wires from START, COM and STOP terminals. The leads may be taped and left in the control. The switch assembly may be removed if a watertight seal is used to cover the hole in the front cover. Connect the remote Start/Stop Switch wires to START (momentary), COM (common) and STOP (constant) terminals, as shown in Figure 11. After applying power, momentarily set the Start/Stop Switch to the “START” position. The motor will run at the set speed of the Main Speed Potentiometer. To stop the motor, set the Start/Stop Switch to the “STOP” position.

FIGURE 11 – REMOTE START/STOP SWITCH CONNECTION

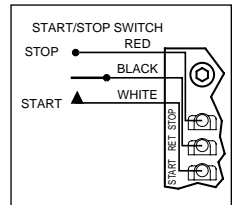

Note: To eliminate the Start/Stop function, connect START and RET terminals with the jumper that is provided, as shown in Figure 12.

FIGURE 12 – START/STOP FUNCTION ELIMINATED (JUMPER INSTALLED)

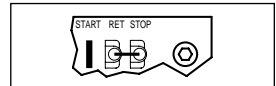

CAUTION! Eliminating the Start/Stop function using a jumper will cause the motor to run at the Main Speed Potentiometer setting when the AC line is applied.

H. Run Relay Connection – Normally open (NO) or normally closed (NC) relay output contacts are available at Terminal Block TB3, which change state when the Start/Stop Switch is set to the “START” position. The contacts will return to their original (“normal”) state when the control is set to the STOP Mode, the AC line is disconnected or times out in Timed Current Limit due to a motor overload. The Run Relay contacts are rated 1 Amp at 30 Volts DC and 0.5 Amp at 125 Volts AC.

TABLE 5 – RUN RELAY OUTPUT CONTACTS

MODE	JUMPER J10 POSITION	RUN RELAY CONTACTS
Run	NO	Closed
	NC	Open
Stop	NO	Open
	NC	Closed
TCL	NO	Open
	NC	Closed

Normally open or normally closed run relay output contacts can be selected depending on the position of Jumper J10. The control is factory set with Jumper J10 set to the “NO” position. If normally closed run relay contacts are required in the STOP Mode, set Jumper J10 to the “NC” position. See Table 5.

If normally open is selected (Jumper J10 set to the “NO” position), the run relay output contacts open when the control is in the STOP Mode and close when the control is started. If normally closed is selected (Jumper J10 set to the “NC” position), the run relay output contacts will close when the control is in the STOP Mode and open when the control is started.

Note: If relay output contacts are not required for your application, Jumper J10 may be set to any position.

I. Voltage Following Connection – An isolated 0 - 10 Volt DC or 0 - 15 Volt DC analog signal voltage can also be used to control motor speed. See Figure 13. **Note:** Jumper J5 must be set to the “10V” position if using a 0 - ±10 Volt DC analog signal voltage or to the “15V” position if using a 0 - ±15 Volt DC analog signal voltage.

FIGURE 13 – VOLTAGE FOLLOWING CONNECTION

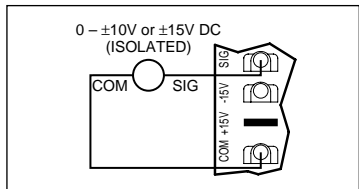

Note: If an isolated signal voltage is not available, install the optional Signal Isolator SIRC (P/N 8842). Connect the isolated signal voltage to SIG (signal) and COM (-) terminals. Adjustment of the MIN trimpot may be necessary to achieve a 0 Volt DC output with a 0 Volt DC input.

J. Enable Circuit Connection – The control can also be started and stopped with an Enable Circuit (close to start). See Figure 14. The Enable function is established by wiring a switch in series with the EN and COM terminals. When the Enable switch is closed, the control will accelerate to the Main Speed Potentiometer setting. When the Enable Switch is opened, the control will either Regenerate-to-Stop or Coast-to-Stop, depending on the setting of Jumper J9, as described in Section IIII, on page 16. Jumper J11 must be removed in order for the Enable Circuit to operate.

FIGURE 14 – ENABLE CIRCUIT CONNECTION

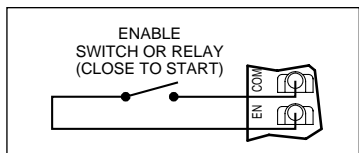

Warning! Do not use Enable as a safety disconnect. Use only the AC line for this purpose.

K. DC Tach-Generator Connection – Wire the tach-generator to T+ and T- terminals of Terminal Block TB3, as shown in Figure 15, on page 14. Jumper J3 must be set to the “7V” position for 7 Volt per 1000 RPM tach-generators or to the “50V” position for 50 Volt per 1000 RPM tach-generators. The tach-generator polarity must match the polarity of

the motor armature voltage. If the tach-generator polarity is reversed, the motor will accelerate to full speed and the Main Speed Potentiometer will not control speed. Tach-generator feedback can greatly improve speed regulation and dynamic response.

Note: When using a tach-generator, the IR trimpot should be set fully counterclockwise.

Note: The tach-generator input is designed for 7 Volt or 50 Volt per 1000 RPM tach-generators used with 1800 RPM motors. For a tach-generator other than 7 Volt or 50 Volt per 1000 RPM or for motors other than 1800 RPM, an external 1/2 Watt resistor (R_T) must be installed. Install R_T in series with the tach-generator, as shown in Figure 16. Jumper J3 must be set to the “7V” position.

FIGURE 15 – DC TACH-GENERATOR CONNECTION

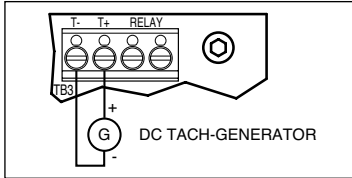
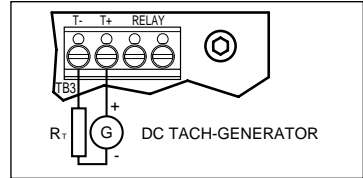

FIGURE 16 – DC TACH-GENERATOR CONNECTION WITH ADDITION OF R_T



The value of R_T in Ω can be calculated using the following formula:

$R_T = (4.37 \times V_T \times S) - 55000$ Where V_T is the tach-generator voltage (in Volts per 1000 RPM) and S is the base speed of the motor (in RPM).

Example:

Suppose you have a 20 Volt per 1000 RPM tach-generator with a 3600 RPM motor.

$R_T = (4.37 \times 20 \times 3600) - 55000 = 259640$

Choose the closest 1/2 Watt resistor value, which is 240000 (240k) or 270000 (270k). Readjustment of the MAX trimpot may be necessary to achieve the desired maximum output voltage.

III. SETTING SELECTABLE JUMPERS

The KBRC-240D has selectable jumpers which must be set before the control can be used. See Figure 1, on page 7, for location of jumpers.

A. AC Line Input Voltage Selection (J1 and J2) –

Jumpers J1 and J2 are both factory set to the “230V” position for 208/230

Volt AC line input. For 115 Volt AC line input, set **both** Jumpers J1 and J2 to the “115V” position. See Figure 17.

FIGURE 17 – AC LINE INPUT VOLTAGE SELECTION

Control Set for 208/230 Volt AC Line Input (Factory Setting)		Control Set for 115 Volt AC Line Input	
J1 Set for 208/230 Volt AC Line	J2 Set for 208/230 Volt AC Line	J1 Set for 115 Volt AC Line	J2 Set for 115 Volt AC Line
J1 230V 115V	J2 J2 115V 230V	J1 230V 115V	J2 J2 115V 230V

B. Motor Voltage Selection (J3) – Jumper J3 is factory set to the “A180” position for 180 Volt motors. For 90 Volt motors, set Jumper J3 to the “A90” position. See Figure 18.

FIGURE 18 – MOTOR VOLTAGE SELECTION

J3 Set for 180 Volt Motor (Factory Setting)	J3 Set for 90 Volt Motor
J3	J3

Note: If Jumper J3 is set to the “T7” or “T50” position, a tach-generator must be wired to Terminal Block TB3. If a tach-generator is not used, Jumper J3 must be in either the “A180” or “A90” position. If jumper J3 is in the “T7” or “T50” position, and a tach-generator is not used, the motor will accelerate to full speed and the Main Speed Potentiometer will not control speed.

C. DC Tach-Generator Voltage Selection (J3) – Jumper J3 is factory set to the “A180” position for 180 Volt motors. When connecting a tach-generator to Terminal Block TB3, set Jumper J3 to the corresponding voltage of the tach-generator being used. See Figure 19.

Note: If using a tach-generator other than 7V or 50V per 1000 RPM, see Section IIIK, on page 13.

FIGURE 19 – DC TACH-GENERATOR VOLTAGE SELECTION

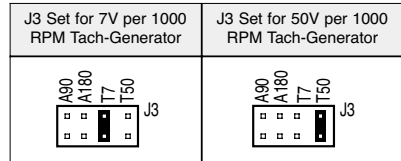

D. Motor Current Selection (J4) – Jumper J4 is factory set to the “10A” position for 10 Amp motors. For lower current motors, set Jumper J2 to the corresponding current of the motor being used. See Figure 20 and Table 6.

FIGURE 20 – MOTOR CURRENT SELECTION

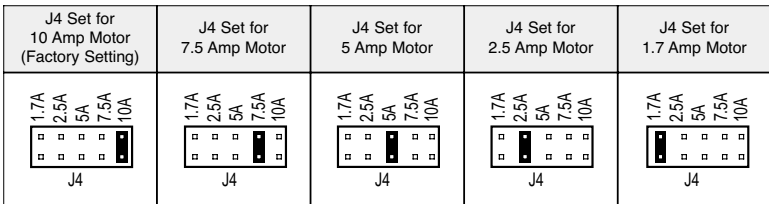
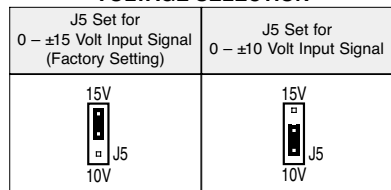

TABLE 6 – SETTING MOTOR CURRENT

J4 Setting (Amps DC)	SCR Rated Motor Horsepower – HP, (kW)	
	90 Volt DC Motors	180 Volt DC Motors
1.7	1/6, (0.1)	1/3, (0.25)
2.5	1/4, (0.18)	1/2, (0.37)
5.0	1/2, (0.37)	1, (0.75)
7.5	3/4, (0.5)	1½, (1)
10	1, (0.75)	2, (1.5)

E. Analog Input Signal Voltage Selection (J5) – Jumper J5 is factory set to the “15V” position for use with a potentiometer to control motor speed. To control motor speed using a 0 - ±10 Volt DC **isolated** analog signal voltage set Jumper J5 to the “10V” position. To control motor speed using a 0 - ±15 Volt DC **isolated** analog signal voltage, set Jumper J5 to the “15V” position. See Figure 21.

FIGURE 21 – ANALOG INPUT SIGNAL VOLTAGE SELECTION



Note: Connect the isolated signal voltage to SIG (signal) and COM (-) terminals. If an **isolated** analog signal voltage is not available, install the optional Signal Isolator SIRC (P/N 8842).

F. Control Mode Selection (J6) – Jumper J6 is factory set to the “SPD” position for Speed Control Mode. For Torque Control Mode, set Jumper J6 to the “TRQ” position. See Figure 22.

G. Torque Control Mode Selection (J7) – Jumper J7 is factory set to the “S/L” position for Speed Mode and Linear Torque Mode. For Non-Linear Torque Mode, set Jumper J7 to the “NL” position. See Figure 23. (See Section VI, on page 18.)

H. Current Limit Mode Selection (J8) – Jumper J8 is factory set to the “TCL” position for Timed Current Limit operation. For Non-Timed Current Limit operation, set Jumper J8 to the “NTCL” position. See Figure 24.

TCL (Timed Current Limit) – When Jumper J8 is set to the “TCL” position, the control will go into Stop Mode after it is in overload for a predetermined amount of time (set by the TCL trimpot).

Resetting the Control after TCL – To reset the control after it has gone into TCL, set the Start/Stop Switch to the “STOP” position and then momentarily to the “START” position or disconnect and reconnect the AC line. If the Start/Stop Switch is jumpered (START and COM terminals connected), the control must be restarted by disconnecting and reconnecting the AC line. If the Power On/Off Switch is installed, set it to the “OFF” position and then back to the “ON” position.

 **Warning!** When the control shuts down in TCL, the AC line voltage is still present in the control.

NTCL (Non-Timed Current Limit) – When Jumper J8 is set to the “NTCL” position, the control will not go into Stop Mode after it is in overload.

Note: The TCL trimpot will have no affect when Jumper J8 is in the “NTCL” position.

I. Stop Mode Selection (J9) – Jumper J9 is factory set to the “RTS” position, for Regenerate-to-Stop Mode. For Coast-to-Stop Mode, set Jumper J9 to the “CTS” position. See Figure 25.

J. Run Relay Output Mode Selection (J10) – Jumper J10 is factory set to the “NO” position for normally open relay output contacts at Terminal Block TB3. For normally closed relay output contacts, set Jumper J10 to the “NC” position. See Figure 26.

FIGURE 22 – CONTROL MODE SELECTION



J6 Set for Speed Control Mode (Factory Setting)	J6 Set for Torque Control Mode
TRQ SPD  J6	TRQ SPD  J6

FIGURE 23 – TORQUE MODE SELECTION



J7 Set for Speed Mode and Linear Torque Mode (Factory Setting)	J7 Set for Non-Linear Torque Mode
S/L  NL J7	S/L  NL J7

FIGURE 24 – CURRENT LIMIT MODE SELECTION



J8 Set for Timed Current Limit (Factory Setting)	J8 Set for Non-Timed Current Limit
TCL J8  NTCL	TCL J8  NTCL

FIGURE 25 – STOP MODE SELECTION







J9 Set for Regenerate-to-Stop Mode (Factory Setting)	J9 Set for Coast-to-Stop Mode
RTS J9  CTS	RTS J9  CTS

FIGURE 26 – RUN RELAY OUTPUT MODE SELECTION

J10 Set for Normally Open Run Relay Output Contacts (Factory Setting)	J10 Set for Normally closed Run Relay Output Contacts
J10 NC  NO	J10 NC  NO

K. Enable Jumper (J11) – Jumper J11 is factory installed to enable the control. If installing the Enable Circuit, as described in Section IIJ, on page 13, remove Jumper J11. See Figure 27.

FIGURE 27 – ENABLE JUMPER

J11 Installed for Auto-Enable (Factory Setting)	J11 Not installed for Manual Enable
EN  J11	EN  J11

IV. MOUNTING INSTRUCTIONS



Warning! The KBRC-240D is not designed to be used in an explosion-proof application.

It is recommended that the control be mounted vertically on a flat surface with adequate ventilation. Leave enough room below the control to allow for AC line, motor connections and any other wiring. Although the control is designed for outdoor and wash down use, care should be taken to avoid extreme hazardous locations where physical damage can occur. If the control is mounted in a closed, unventilated location, allow enough room for proper heat dissipation. If operating the control at full rating, a minimum enclosure size of 12"W X 24"H X 12"D is required. See Figure 3, on page 8.

V. RECOMMENDED HIGH VOLTAGE DIELECTRIC WITHSTAND TESTING (Hi-Pot Testing)

Testing agencies such as UL, CSA, VDE, etc., usually require that equipment undergo a hi-pot test. In order to prevent catastrophic damage to the speed control, which has been installed in the equipment, it is recommended that the following procedure be followed. Figure 28 shows a typical hi-pot test setup.

Note: All equipment AC line inputs must be disconnected from the AC power.

A. Connect all equipment AC power input lines together and connect them to the H. V. lead of the hi-pot tester. Connect the RETURN lead of the hi-pot tester to the frame on which the control and other auxiliary equipment are mounted.

FIGURE 28 – HI-POT TEST SETUP

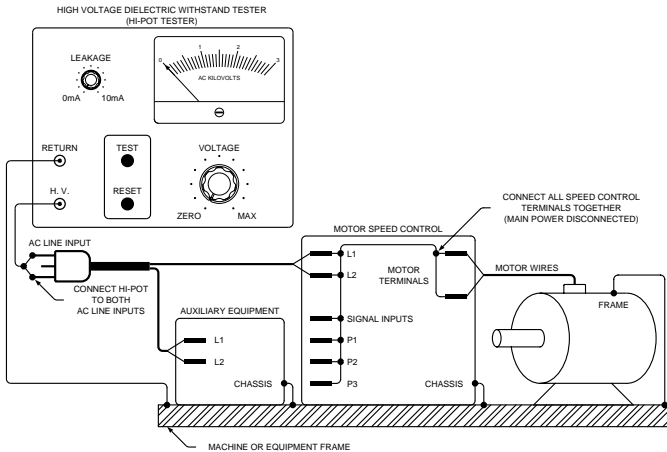

B. The hi-pot tester must have an automatic ramp-up to the test voltage and an automatic ramp-down to zero voltage.

Note: If the hi-pot tester does not have automatic ramping, then the hi-pot output must be manually increased to the test voltage and then manually reduced to zero. This procedure must be followed for each machine tested. A suggested hi-pot tester is Slaughter Model 2550.



WARNING! Instantaneously applying the hi-pot voltage will cause irreversible damage to the speed control.

- C. The hi-pot test voltage should be set in accordance to the testing agency standards and the leakage current should be set as low as possible without causing nuisance trips.
- D. To eliminate motor speed control damage due to auxiliary equipment hi-pot failure, it is also recommended that all signal inputs be wired together and connected to the AC input lines as shown.

VI. OPERATION

After the KBRC-240D has been properly setup (jumpers set to desired positions and wiring completed), the startup procedure can begin. If AC power has been properly brought to the control, the ON and STOP LEDs will be illuminated. Before starting, be sure that the Main Speed Potentiometer is set to the zero speed position. To start the control, momentarily set the Start/Stop Switch to the “START” position. The STOP LED should no longer illuminate. The motor should begin to run as the Main Speed Potentiometer is rotated.

Note: If the motor runs in the incorrect direction, it will be necessary to disconnect the AC line, reverse the motor leads and repeat the startup procedure.

TABLE 7 – CONTROL OPERATION

Quadrant	Type of Operation	Motor Rotation Direction	Motor Torque Direction	Load Torque Direction
I	Motoring	CW	CW	CCW
II	Regeneration	CCW	CW	CCW
III	Motoring	CCW	CCW	CW
IV	Regeneration	CW	CCW	CW

Linear Torque Mode:

In Linear Torque mode (Jumper J7 set to the “S/L” position), speed and torque vary linearly as a function of Main Speed Potentiometer rotation or input signal. See Figure 29.

Non-Linear Torque Mode:

In Non-Linear Torque mode (Jumper J7 set to the “NL” position), the torque is varied by the Main Speed Potentiometer or input signal, and remains constant throughout the motor’s entire speed range. See Figure 30.

FIGURE 29 – LINEAR TORQUE MODE

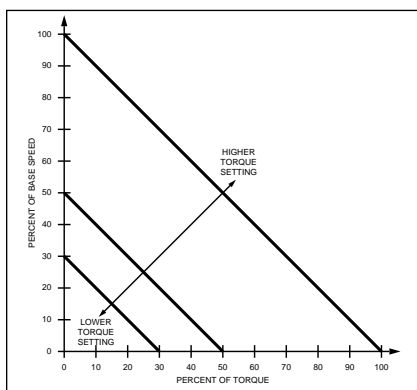
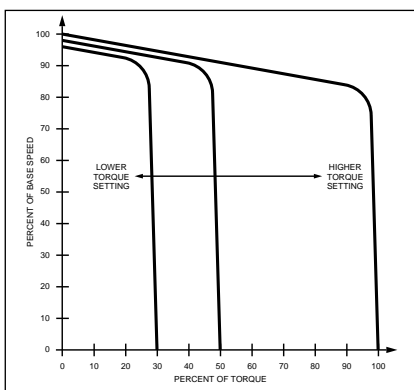

FIGURE 30 – NON-LINEAR TORQUE MODE



VII. AC LINE FUSING

The KBRC-240D does not contain AC line fuses. Most electrical codes require that each ungrounded conductor contain circuit protection. It is recommended to install a 20 Amp fuse (Littelfuse 326, BUSS ABC or equivalent) or a circuit breaker in series with each ungrounded conductor. Check all electrical codes that apply to the application.

VIII. TRIMPOT ADJUSTMENTS

The KBRC-240D contains trimpots which are factory set for most applications. Figure 2, on page 7, illustrates the location of the trimpots and their approximate calibrated positions. Some applications may require readjustment of the trimpots in order to tailor the control for a specific requirement. Readjust trimpots as described below.



Warning! If possible, do not adjust trimpots with the main power applied. If adjustments are made with the main power applied, an insulated adjustment tool must be used and safety glasses must be worn. High voltage exists in this control. Fire and/or electrocution can result if caution is not exercised. Safety Warning, on page 5, must be read and understood before proceeding.

A. Offset (OFFSET) – Sets the amount of bias in the forward or reverse direction. The OFFSET trimpot is factory set for approximately zero offset, which means that neither the forward nor reverse direction is favored. To offset the control in the forward direction, rotate the OFFSET trimpot clockwise. To offset the control in the reverse direction, rotate the OFFSET trimpot counterclockwise. See Figure 31 and Figure 32.

B. Forward Acceleration (FACC) and Reverse Acceleration (RACC) – Sets the amount of time it takes the control voltage to reach full output. The FACC and RACC trimpots are factory set to 1 second. See Figure 33, Figure 34 and Figure 35.

The FACC trimpot sets the amount of time it takes the control voltage to reach full output in the forward direction. It also sets the amount of time it takes the control voltage, in the reverse direction, to reach zero output (FACC also sets the reverse deceleration time). To increase the forward acceleration time, rotate the FACC trimpot clockwise. To decrease the forward acceleration time, rotate the FACC trimpot counterclockwise.

The RACC trimpot sets the amount of time it takes the control voltage to reach full output in the reverse direction. It also sets the amount of time it takes the control voltage, in the forward direction, to reach zero

FIGURE 31 – OFFSET TRIMPOT RANGE

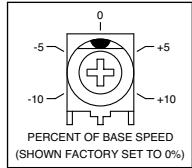

FIGURE 32 – OFFSET TRIMPOT ADJUSTMENT

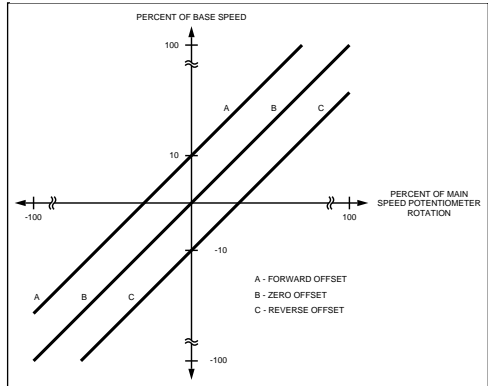

FIGURE 33 – FACC TRIMPOT RANGE

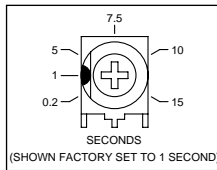

FIGURE 34 – RACC TRIMPOT RANGE

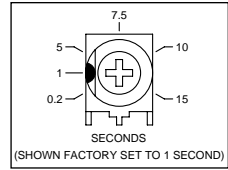
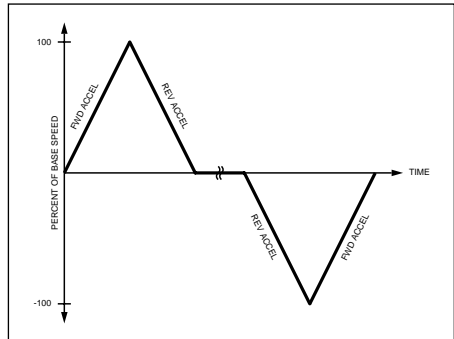

FIGURE 35 – FACC AND RACC TRIMPOT ADJUSTMENT



output (RACC also sets the forward deceleration time). To increase the reverse acceleration time, rotate the RACC trimpot clockwise. To decrease the reverse acceleration time, rotate the RACC trimpot counterclockwise.

- C. Maximum Speed (MAX)** – Sets maximum speed of the motor. The MAX trimpot is factory set for 100% of base motor speed. For a higher maximum speed setting, rotate the MAX trimpot clockwise. For a lower maximum speed setting, rotate the MAX trimpot counterclockwise. See Figure 36.

FIGURE 36 – MAX TRIMPOT RANGE

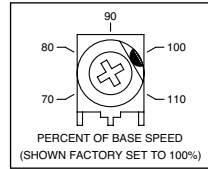

To Calibrate the MAX Trimpot:

1. Adjust the MAX trimpot to the desired position and set the Main Speed Potentiometer for full output voltage.
2. Monitor the armature voltage and readjust the MAX trimpot to the desired voltage.

- D. Forward Current Limit (FWDCL) and Reverse Current Limit (REVCL)** – Sets the current limit (overload), which limits the maximum current to the motor. The FWDCL and REVCL trimpots are factory set for 150% of J4 range setting. See Figure 37 and Figure 38.

FIGURE 37 – FWDCL TRIMPOT RANGE

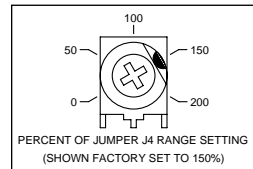

The FACC trimpot sets the current limit in the forward direction. To increase the forward current limit, rotate the FWDCL trimpot clockwise. To decrease the forward current limit, rotate the FWDCL trimpot counterclockwise.

FIGURE 38 – REVCL TRIMPOT RANGE

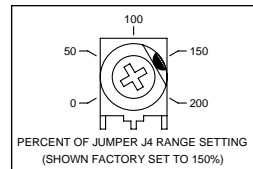

The RACC trimpot sets the current limit in the reverse direction. To increase the reverse current limit, rotate the REVCL trimpot clockwise. To decrease the reverse current limit, rotate the REVCL trimpot counterclockwise.

CAUTION! Adjusting the FWDCL or REVCL above 150% of motor rating can cause overheating and demagnetization of some PM motors. Consult the motor manufacturer. Do not leave the motor in a locked condition for more than a few seconds since armature damage may occur.

To Calibrate the FWDCL or REVCL Trimpot:

1. Disconnect the AC power. Wire in a DC ammeter in series with either motor armature lead. Lock motor shaft. Be sure that Jumper J4 is set to the corresponding motor current position. Set Jumper J8 to the “NTCL” position. Set Jumper J8 to the “NTCL” position.
2. Set the FWDCL trimpot (if in the forward direction) or the REVCL trimpot (if in the reverse direction) fully counterclockwise.
3. Apply power. Adjust the FWDCL trimpot (if in the forward direction) or the REVCL trimpot (if in the reverse direction) until the desired current limit (CL) setting is reached.

WARNING! Do not leave the motor shaft locked for more than 2 - 3 seconds or motor damage may result.

- E. IR Compensation (IR)** – Sets the amount of compensating voltage required to keep the motor speed constant under changing loads. The IR trimpot is factory set for 10 Volts (at 180 Volts DC output) and 5 Volts (at 90 Volts DC output). For higher compensating voltage, rotate the IR trimpot clockwise. For lower compensating voltage, rotate the IR trimpot counterclockwise. See Figure 39.

FIGURE 39 – IR TRIMPOT RANGE

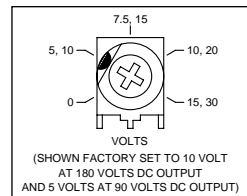

Note: If the IR compensation is too high, unstable (oscillatory) operation will result. If the control is used with a DC tach-generator, the IR trimpot should be set fully counterclockwise.

To Calibrate the IR Trimpot:

1. Run the motor at approximately 30 - 50% of rated speed at no load and measure the actual speed.
2. Load the motor to the rated current. Adjust the IR trimpot so that the loaded speed is the same as the unloaded speed measured in step 1.

F. Response (RESP): Sets the relative response of the control. The RESP trimpot is factory set to 50% rotation. For faster response, rotate the RESP trimpot clockwise. For slower response, rotate the RESP trimpot counterclockwise. See Figure 40. **Note:** If response is made too rapid, unstable, oscillatory operation may result.

FIGURE 40 – RESP TRIMPOT RANGE

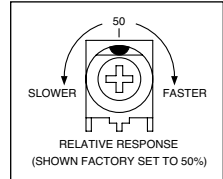

G. Deadband (DB): Sets the amount of Main Speed Potentiometer rotation required to initiate control voltage output. The OFFSET trimpot is factory set to 0.5% of base speed. For more deadband, rotate the DB trimpot clockwise. For less deadband, rotate the DB trimpot counterclockwise. See Figure 41 and Figure 42.

FIGURE 41 – DB TRIMPOT RANGE

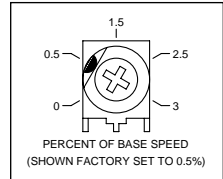

The DB trimpot also determines the amount of delay that will occur before regeneration begins. (Regeneration occurs when the applied load torque is in the same direction as the motor rotation.)

To Calibrate the DB Trimpot:

1. Set the Main Speed Potentiometer to the zero speed position.
2. Set the DB trimpot fully counterclockwise.
3. Adjust the DB trimpot until motor hum is eliminated.

FIGURE 42 – DB TRIMPOT ADJUSTMENT

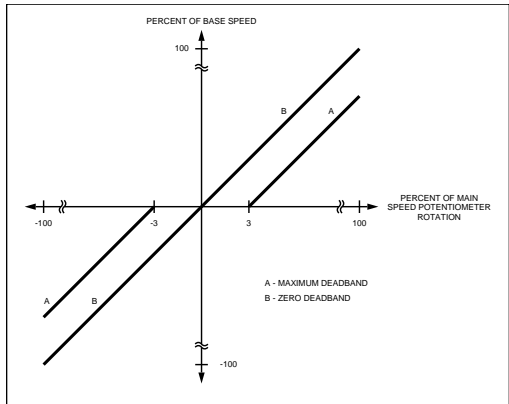

Note: If the DB trimpot is set too low (counterclockwise position), the motor may oscillate between forward and reverse directions. Adjust the DB trimpot clockwise until the instability disappears. (Oscillation may also occur due to the setting of the RESP trimpot. See Section VIII.F.)

H. Timed Current Limit (TCL) – Sets the time for the control to shut down after being in current limit (provides electronic motor burnout protection). The TCL trimpot is factory set for 5 seconds. To increase the TCL setting, rotate the TCL trimpot clockwise. To decrease the TCL setting, rotate the TCL trimpot counterclockwise. If the control remains in CL for a pre-determined amount of time (set by the TCL trimpot and if Jumper J8 is in the "TCL" position), the control will shut down.

FIGURE 43 – TCL TRIMPOT RANGE

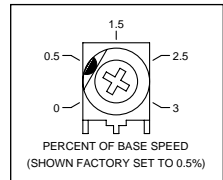

To reset the control after it has gone into TCL, momentarily set the Start/Stop switch to the "START" position or disconnect and reconnect the AC line. See Figure 43, on page 21.

Resetting the Control after TCL – To reset the control after it has gone into TCL, set the Start/Stop switch to the "STOP" position and then momentarily to the "START" position or disconnect and reconnect the AC line. If the Start Switch is jumpered (START and COM terminals connected) the control must be restarted by disconnecting and reconnecting the AC line. If the Power On/Off Switch is installed, set it to the "OFF" position and then back to the "ON" position.

To Calibrate the TCL Trimpot:

1. Run the motor at approximately 30 -50% of rated speed at no load.
2. With Jumper J8 set to the "TCL" position, set the TCL trimpot to the desired position and lock the motor shaft.
3. Monitor the time it takes for the control to shut down.
4. If the TCL time is not as desired, reset the control and repeat steps 1 - 3.

Warning! When the control shuts down in TCL, the AC line voltage is still present in the control.

Non-Timed Current Limit (NTCL) – When jumper J3 is set to the "NTCL" position and an overload condition exists, the control will remain in current limit and will not shut down.

IX. DIAGNOSTIC LEDs

The KBRC-240D is designed with LEDs mounted on the front cover to display the control's operational status.

- A. Power On (ON):** The ON LED will illuminate green when the AC line is applied to the control.
- B. Stop (STOP):** The STOP LED will illuminate yellow when the Start/Stop switch is set to the "STOP" position. When the AC line is applied, this LED will also be illuminated until the Start/Stop switch is momentarily set to the "START" position.
- C. Overload (OL):** The OL LED will illuminate red when the control goes into current limit, indicating that the current limit set point has been reached (set by the CL trimpot and the position of jumper J4). This LED will remain illuminated if the control times out in TCL (Jumper J8 set to the "TCL" position).

The control can be reset by either setting the Start/Stop Switch to the "STOP" position and then momentarily to the "START" position or by disconnecting and reconnecting the AC line. If the overload condition still exists when the control is restarted or AC line reapplied, the OL LED will illuminate again. If the OL LED remains illuminated during normal control operation, a fault condition may exist. Possible causes for this condition are as follows.

1. Motor is overloaded. Check motor current. If the motor is a shunt wound type, the field may be open or not receiving proper voltage.
2. Motor may be defective. Check motor for shorts or grounds.
3. CL may be set too low. Check position of CL trimpot and setting of jumper J4.

Note: In some applications, especially those requiring the motor to cycle on and off or from one speed to another or from stop to high speed, the OL LED may blink, indicating a transient overload. This may be a normal condition for the application.

X. OPTIONAL ACCESSORIES

Complete instructions and connection diagrams are supplied with all accessories to facilitate installation.

- A. Forward-Stop-Reverse Switch (P/N 9485)** – Provides motor reversing and regenerative braking. Mounts on the enclosure cover and is supplied with a switch seal to maintain watertight integrity.
- B. Power On/Off Switch (P/N 9486)** – Disconnects the AC line. Mounts on the enclosure cover and is supplied with a switch seal to maintain watertight integrity.
- C. Signal Isolator SIRC (P/N 8842)** – Provides isolation between a non-isolated signal voltage source and the KBRC-240D. Mounts on the inside of the enclosure cover.
- D. Auto/Manual Switch (P/N 9487)** – When used with the SIRC, it selects either an isolated signal from the SIRC or from the Main Speed Potentiometer. Mounts on the enclosure cover and is supplied with a switch seal to maintain watertight integrity.
- E. KBRF-200 RFI Filter (P/N 9945)** – Provides RFI and EMI suppression. Meets CE directives.

XI. LIMITED WARRANTY

For a period of 18 months from the date of original purchase, KB Electronics, Inc. will repair or replace, without charge, devices which our examination proves to be defective in material or workmanship. This warranty is valid if the unit has not been tampered with by unauthorized persons, misused, abused, or improperly installed and has been used in accordance with the instructions and/or ratings supplied. The foregoing is in lieu of any other warranty or guarantee, expressed or implied. KB Electronics, Inc. is not responsible for any expense, including installation and removal, inconvenience, or consequential damage, including injury to any person, caused by items of our manufacture or sale. Some states do not allow certain exclusions or limitations found in this warranty and therefore they may not apply to you. In any event, the total liability of KB Electronics, Inc., under any circumstance, shall not exceed the full purchase price of this product. (rev 2/2000)



KB Electronics, Inc.

12095 NW 39th Street, Coral Springs, FL 33065-2516 • (954) 346-4900 • Fax (954) 346-3377
Outside Florida Call TOLL FREE (800) 221-6570 • E-mail – info@kbelectronics.com
www.kbelectronics.com