

INSTALLATION AND OPERATING INSTRUCTIONS

REGENERATIVE DRIVE

MODEL KBRG-225D

MODEL KBRG-240D

(P/N 8800)

(P/N 8802)

FULL WAVE • 4 QUADRANT

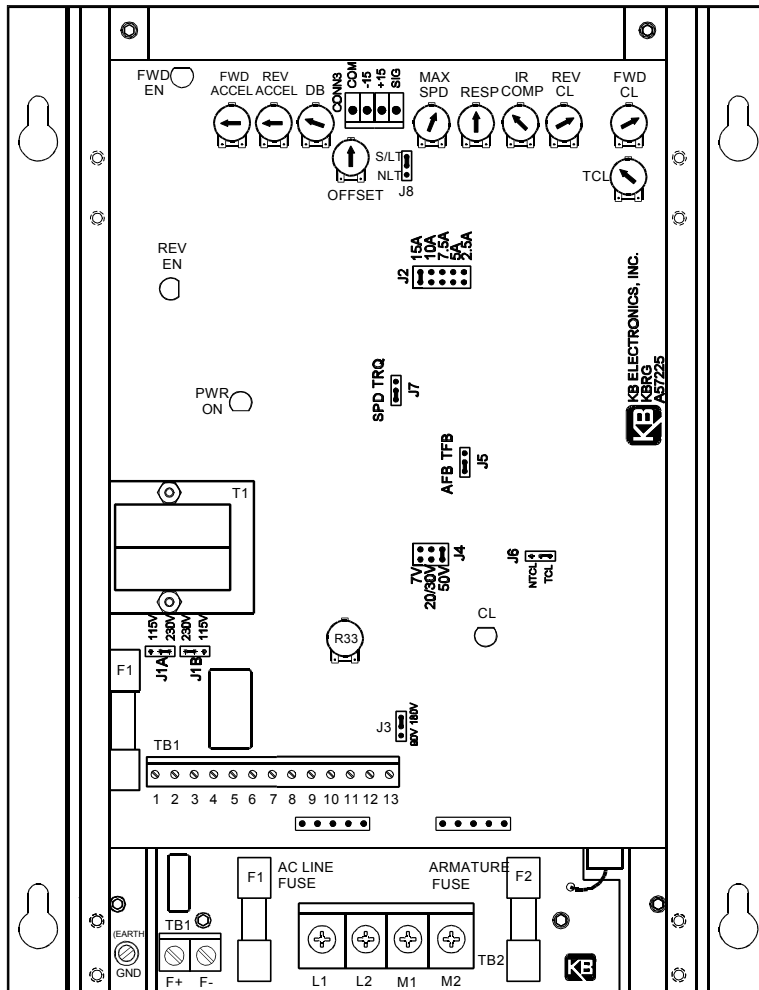

This manual applies to logic board revision "L" and newer controls only.

 **See Safety Warning on Page 2**

The information contained in this manual is intended to be accurate. However, the manufacturer retains the right to make changes in design which may not be included herein.

CE
See Page 2

UL US

PENTA  POWER

A COMPLETE LINE OF MOTOR DRIVES

© 1997 KB Electronics, Inc.

TABLE OF CONTENTS

<u>Section</u>	<u>Page</u>
i. Simplified Setup and Operating Instructions	1
ii. Safety Warning	2
I. General Information	2
II. Setting Mode of Drive (Speed or Torque Control)	4
III. Setting Selectable Jumpers	6
IV. Mounting	8
V. Wiring	8
VI. Fusing	12
VII. Operation	12
VIII. Trimpot Adjustments	13
IX. Function Indicator Lamps	15
X. Limited Warranty	22

TABLES

1. Electrical Ratings	2
2. General Performance Specifications	4
3. Summary of Control Operation	5
4. Jumper J2 Position vs Motor Horsepower	6
5. Relationship of AC Line Input and Motor Voltage	7
6. Terminal Block Wiring Information	8
7. Field Connections	10
8. Control State vs Relay Contact State	12
9. Armature Fuse Chart	13
10. Current Limit Timer Settings	15
11. Parts List (Logic Board)	16, 17
12. Parts List (Power Board)	19

FIGURES

1. Control Layout	3
2A. Linear Torque Curve	5
2B. Non-Linear Torque Curve	6
3. AC Line Voltage Jumper Setting	7
4. Motor Armature Voltage Jumper Setting	7
5. Mechanical Specifications	9
6. AC Line and Armature Connection	10
7A. Full Voltage Field	10
7B. Half Voltage Field	10
8. Main Speed Potentiometer Connections	11
9A. Voltage Following	11
9B. Enable	11
9C. Start/Stop Circuit	11
9D. Alarm Contacts	11
9E. Tach-generator Connection	12
10. Accel Trimpot Adjustment	13
11. Offset Trimpot Adjustment	14
12. Deadband Trimpot Adjustment	14
13. Logic Board Schematic	18
14. Power Board Schematic	20

i.   **KBRG SIMPLIFIED OPERATING INSTRUCTIONS**

IMPORTANT – You must read these simplified operating instructions before you proceed. These instructions are to be used as a reference only and are not intended to replace the detailed instructions provided herein. You must read the Safety Warning on page 2 before proceeding.

1. CONNECTIONS.

A. AC Line – Wire AC line voltage to terminals L1 and L2. Be sure jumpers J1A and J1B are both set to the correct input line voltage of 115 or 230 VAC. Connect ground wire (earth) to green ground screw.

B. Motor.

1. Permanent Magnet (PM Type). Connect motor armature leads to M1+ and M2-. Be sure jumper J3 is set to the proper position “90” for 90 volt DC motors and “180” for 180 volt DC motors. Note: 180 volt DC motors must be used with 230 VAC line, 90 volt motors can be used with a 230 VAC or 115 VAC line. Note: Motor performance and efficiency, including brush life, may be adversely affected when using 90 volt motors with a 230 VAC line.
2. Shunt Wound Motors. Connect motor armature as above. Connect full voltage shunt field wires (90 volt motors with 100 volt fields and 180 volt with 200 volt fields) to F+ and F-. Connect half voltage field wires (90 volt motors with 50 volt fields and 180 volt motors with 100 volt fields) to F+ and L1.

2. SPEED OR TORQUE MODE.

Jumper J7 is factory set for speed control operation (SPD). For torque control, set J7 to TRQ position. Note: J8 must be set to the “S/LT” position for speed control operation.

3. MOTOR CURRENT.

Jumper J2 is factory set for 15 amp motors (15A) on the KBRG-225D and 10 amp motors (10A) on the KBRG-240D. For lower amperage motors, place J2 in the proper position. If motor amperage is less than 2.5 amps, which is the lowest value on both models, use the 2.5A position and readjust the IR and both CL trimpots according to section VIII D and E on pages 14 and 15 .

Note: The factory setting for Current Limit is 150% of the nominal current setting (e.g., if J2 is selected for 5 amps, the actual CL setting will be 7.5 amps).

4. TRIMPOT SETTINGS.

All trimpots have been factory set in accordance with figure 1, page 3.

5. AC LINE FUSE.

The power board on all models contains a single AC line fuse (F1), 25A for KBRG-225D and 20A for KBRG-240D. The AC line fuse protects the unit from catastrophic failure.

6. ARMATURE FUSE.

An armature fuse (F2) is also provided. A 25A armature fuse is installed on the KBRG-225D and a 20A on the KBRG-240D. It is recommended that the correct size armature fuse be installed depending on the rating of the motor and form factor. See table 9, page 13.

7. SIGNAL INPUT.

Connect potentiometer or **isolated** analog input to terminal “10,” “11,” “12” and “13” according to section V, E and F, on pages 10 and 11. Do not ground (earth) signal inputs. Use a signal isolator when controlling multiple drives from a non isolated signal source.



ii. SAFETY WARNING! — PLEASE READ CAREFULLY

This product should be installed and serviced by a qualified technician, electrician or electrical maintenance person familiar with its operation and the hazards involved. Proper installation, which includes wiring, mounting in proper enclosure, fusing or other overcurrent protection and grounding, can reduce the chance of electric shocks, fires or explosion in this product or products used with this product, such as electric motors, switches, coils, solenoids and/or relays. Eye protection must be worn and insulated adjustment tools must be used when working with control under power. This product is constructed of materials (plastics, metals, carbon, silicon, etc.) which may be a potential hazard. Proper shielding, grounding and filtering of this product can reduce the emission of radio frequency interference (RFI) which may adversely affect sensitive electronic equipment. If information is required on this product, contact our factory. It is the responsibility of the equipment manufacturer and individual installer to supply this safety warning to the ultimate user of this product. (SW effective 11/92)

This control contains electronic Start/Stop and Inhibit circuits that can be used to start and stop the control. However, these circuits are never to be used as safety disconnects since they are not fail-safe. Use only the AC line for this purpose.

The input circuits of this control (potentiometer, start/stop, Inhibit) are not isolated from AC line. **Be sure to follow all instructions carefully. Fire and/or electrocution can result due to improper use of this product.**



This product complies with all CE directives pertinent at the time of manufacture.

Contact factory for detailed installation instructions and Declaration of Conformity. Installation of a CE approved RFI filter (KBRF-200A, KB P/N 9945C or equivalent) is required. Additional shielded motor cable and/or AC line cables may be required along with a signal isolator (SI-4X, KB P/N 8801 or equivalent).

I. GENERAL INFORMATION.

The KBRG is a full-wave regenerative control, capable of operating a DC motor (Permanent Magnet or Shunt) in a bidirectional mode. It provides 4-quadrant operation which allows forward and reverse torque in both speed directions. The drive offers excellent controllability, which closely approximates the performance of servo-type drives. Ratings and specifications are presented in tables 1 and 2. Be sure the drive is used within these ratings and specifications.

(Note: Regenerative drives normally produce more motor heating than standard unidirectional SCR speed controls, especially under low speed operation. This should be taken into consideration when specifying motor rating.)



WARNING! Be sure to follow all instructions carefully. Fire or electrocution can result due to improper use of this product. Read Safety Warning.

TABLE 1 – ELECTRICAL RATINGS

Model	Part No.	Input Voltage (VAC)	Max. AC Current (RMS)	Output Voltage (VDC)	Max. DC Output Current (ADC)	Max. Horsepower HP, (KW)
KBRG-240D	8802	115	16	0 – ±90	11	1, (.75)
		230	16	0 – ±180	11	2, (1.5)
KBRG-225D	8800	115	24	0 – ±90	16	1, (1)
		230	24	0 – ±180	16	3, (2)

FIG. 1 – CONTROL LAYOUT

Illustrates Factory Setting of Jumpers and Approximate Trimpot Settings

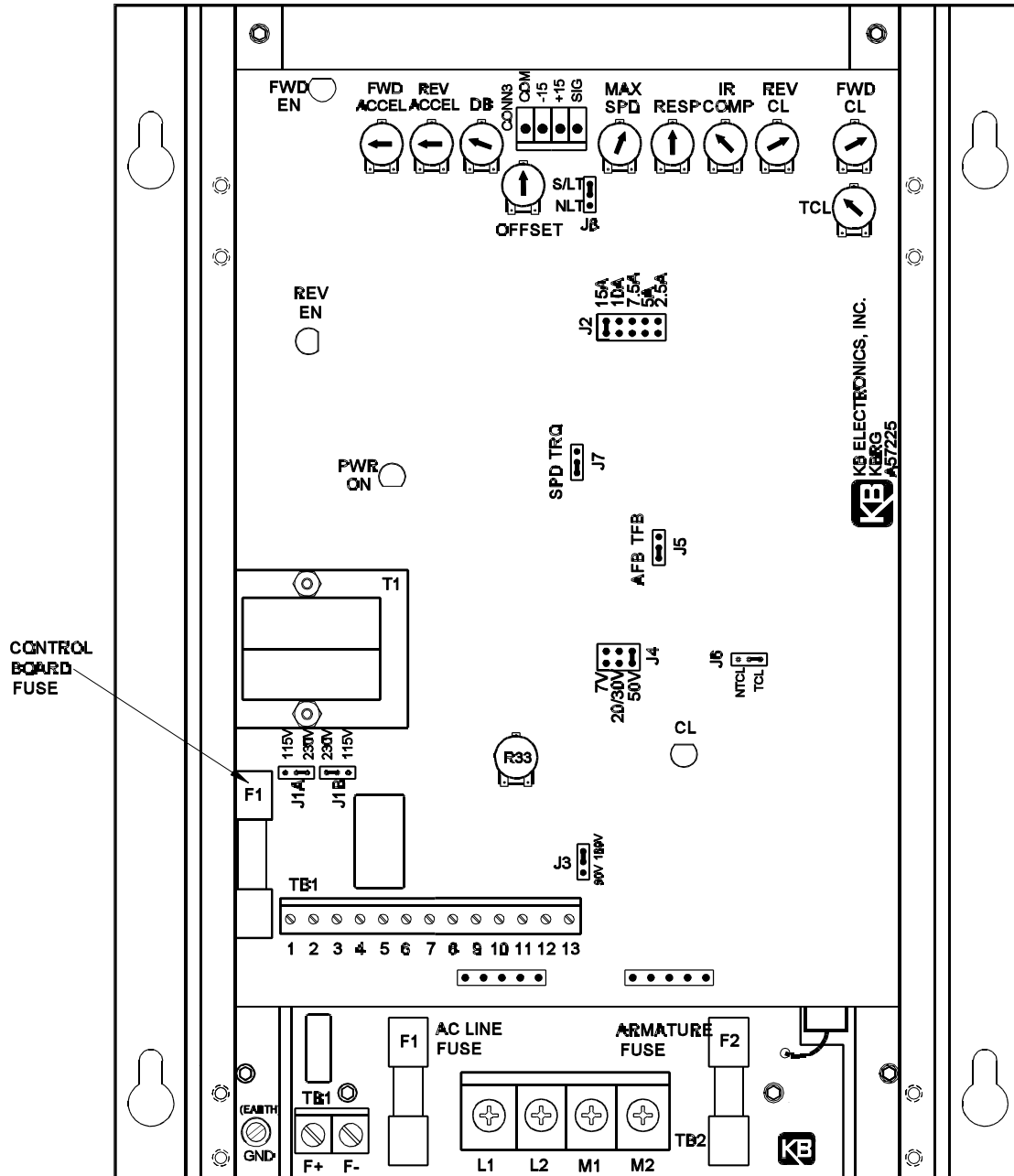

TABLE 2 – GENERAL PERFORMANCE SPECIFICATIONS

Parameter	Specification	Factory Setting
AC Line Input Voltage (VAC $\pm 10\%$, 50/60 Hz)	115 or 230	230
AC Line Frequency (Hz), # of Phases	50/60, 1	—
Arm Voltage Range at 115VAC Line (VDC)	0 – ± 90	—
Arm Voltage Range at 230VAC Line (VDC)	0 – ± 180 , 0 – ± 90	0 – ± 180
Field Voltage at 115VAC Line (VDC)	100/50	—
Field Voltage at 230VAC Line (VDC)	200/100	—
Service Factor	1.0	—
Duty	Continuous	—
Max Load Capacity (% for 2 minutes)	150	—
Ambient Temperature Range ($^{\circ}\text{C}$)	0 – 50 ⁽¹⁾	—
Speed Range (Ratio)	50:1	—
Arm Feedback Load Regulation (% Base Speed)	± 1	—
Tach Feedback Load Regulation (% Set Speed)	± 1	—
Line Regulation (% Base Speed)	± 0.5	—
Current Ranges (ADC)	2.5, 5.0, 7.5, 10, 15 ⁽²⁾	15 or 10
FWD and REV Accel Range (Secs.)	0.1 – 15	1
Dead Band Range (% Base Speed)	0 – ± 3	0
Max Speed Trimpot Range (% Base Speed)	70 – 110	100
IR Comp Range at 115VAC Line (VDC)	0 – 15	5
IR Comp Range at 230VAC Line (VDC)	0 – 30	10
FWD and REV CL Range (% Range Setting)	0 – 150	150
Timed CL Range (Sec.)	1 – 15	5
Voltage Following Input Range (VDC)	0 – ± 10 , 0 – ± 15	0 – ± 15
Voltage Following Linearity (% Base Speed)	± 0.5	—
Tach-generator Voltage Input (Volts)	7,20/30,50	50

Notes:

- (1) Control mounted in vertical position. Maximum ambient temperature in horizontal position is 45 $^{\circ}\text{C}$.
- (2) 15A current range on KBRG-225D only.

II. SETTING MODE OF DRIVE (SPEED OR TORQUE CONTROL).

The KBRG can be operated as a speed control or torque control by setting the position of jumper J7. The main speed potentiometer controls the magnitude of the mode selected. Set jumper J7 to "SPD" for speed control or to "TRQ" for torque control. (See fig. 1, p. 3.)

- A. Speed Control Mode** – When jumper J7 is set to the "SPD" position, the KBRG will vary the motor speed as a function of the voltage on input terminals "12" (signal) and "13" (common). **IMPORTANT: When J7 is set for speed control ("SPD"), J8 must be set to "S/LT" position (factory setting).** The input voltage can be derived from the wiper of the main speed potentiometer or from an *isolated* analog input (voltage following mode). Since the KBRG is a 4-quadrant regenerative drive, the motor speed will follow both a positive and negative wiper voltage and drive the motor in both the forward direction and reverse direction. In addition, it will apply both forward and reverse torque in order to stabilize motor speed.

To understand the concept of a regenerative drive, the operation of an elevator can be used. If one were to enter the elevator on the first floor and press 10, the motor and control would have to lift the elevator against gravity. In this mode, the drive would operate like a conventional speed control which is called "motoring" (the applied load is opposite to the direction of motor rotation). When the elevator is at floor 10 and floor 1 is pressed, gravity will try to pull the elevator car down faster than the speed for which it is set. The control will then provide reverse torque to keep the car from falling faster than the set speed. This operation is regeneration (the applied load is in the same direction as the direction of motor rotation). Table 3 on page 5 summarizes the different modes of regen operation.

TABLE 3 – SUMMARY OF CONTROL OPERATION

Quadrant	Type of Operation	Motor Rotation Direction	Motor Torque Direction	Applied Load Direction
I	Motoring	CW	CW	CCW
II	Regeneration	CCW	CW	CCW
III	Motoring	CCW	CCW	CW
IV	Regeneration	CW	CCW	CW

B. Torque Control Mode – When Jumper J7 is set to “TRQ” position, the KBRG will vary motor torque. The KBRG has been redesigned and now contains two (2) types of torque characteristics which are selectable with jumper J8. Speed/Linear Torque (S/LT) and Non Linear Torque (NLT). In the “S/LT” position (factory setting), both output torque and motor speed vary linearly as a function of the input signal. The “S/LT” type of torque is most suitable for take up and pay out winders where the speed and torque requirements vary as the winder roll diameter changes. The “S/LT” torque characteristics are shown in fig. 2A.

FIG. 2A – LINEAR TORQUE CURVE

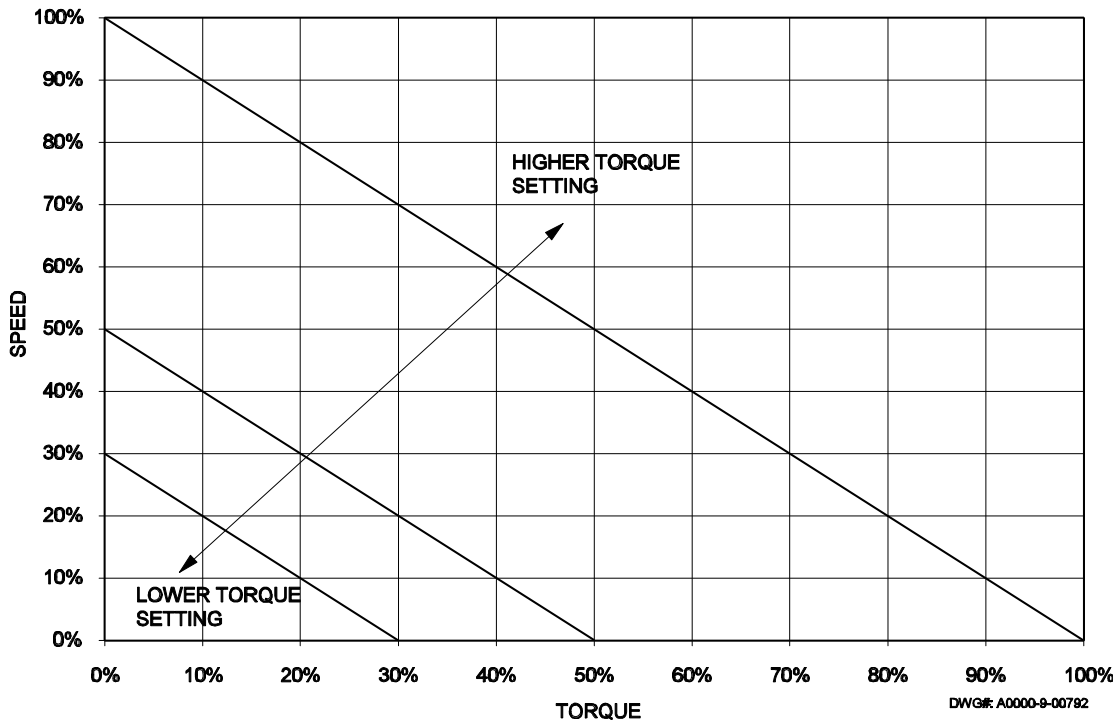

In the “NLT” position, only torque (not speed) is varied by the input signal. The motor output torque remains constant over the motor’s full speed range unless the load is less than the set torque. If the load torque decreases below the set torque, the motor will rapidly increase to full speed. This type of torque control is applicable to processes where the torque must remain constant over a wide motor speed range. The “NLT” torque characteristics are shown in fig. 2B p. 6.

Because the KBRG is a regenerative control, torque will be applied in both forward and reverse directions. The maximum torque can be set with the FWD CL and REV CL trimpots, and by using the FWD ACCEL and REV ACCEL trimpots, the rate of change of torque can be made more or less gradual. The maximum speed trimpot can be used to set the maximum motor speed under a no load condition.

FIG. 2B – NON-LINEAR TORQUE CURVE

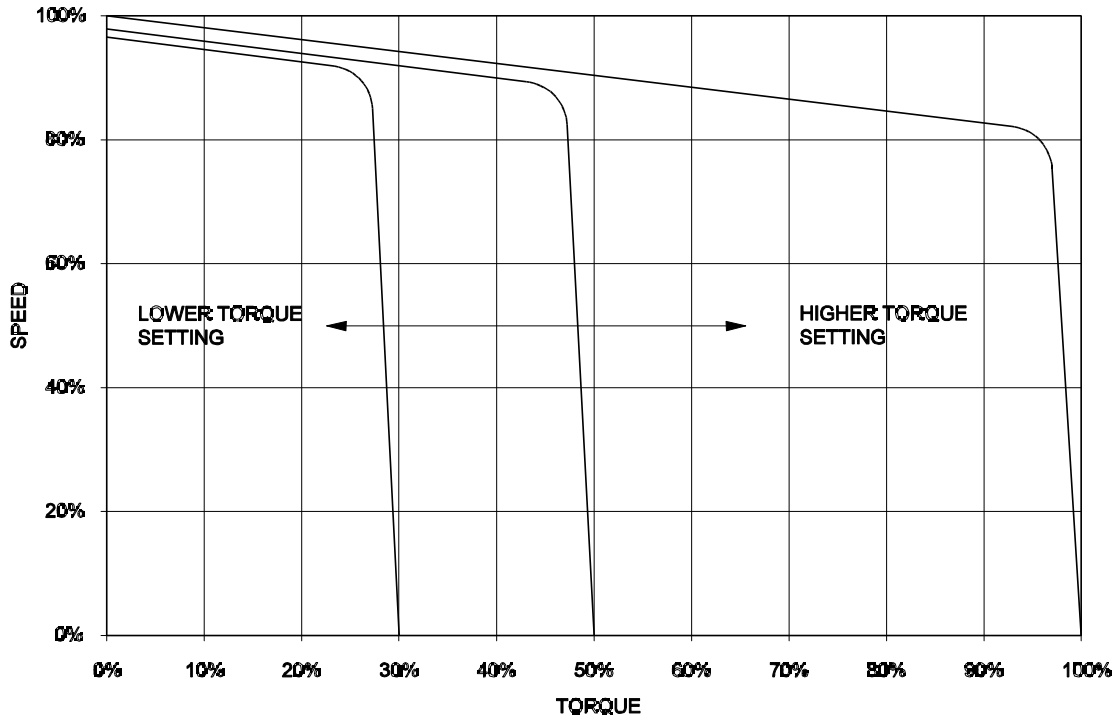

III. SETTING SELECTABLE JUMPERS.

The KBRG has customer selectable jumpers which must be set before the control can be used (refer to fig. 1 p. 3). **Bold** indicates Factory Setting. (See sec. II, p. 4 for J7 and J8 settings.)

- A. J1A, J1B - Input AC Line Voltage** – Select proper input line voltage, 115VAC or 230VAC, by placing both jumpers (J1A and J1B) in the correct corresponding position, "115" or "230." See fig. 3.
- B. J2 - Armature Current** – Select the J2 position (2.5, 5, 7.5, 10, **15**) closest to the rated motor current. (Note: The maximum output current is set to 150% of the J2 position, which may be readjusted using the FWD CL and REV CL trimpots.) **Note: On Model KBRG-240D, position 10A is factory setting.**

TABLE 4 – JUMPER J2 POSITION vs MOTOR HORSEPOWER

	Jumper J2 Position Motor Current (DC Amps)	Motor Horsepower	
		90VDC	180VDC
15A	15A ⁽¹⁾	1	3
10A	10A	1	2
7.5A	7.5A	3/4	1
5.0A	5.0A	1/2, 1/3	1, 3/4
2.5A	2.5A	1/4	1/2

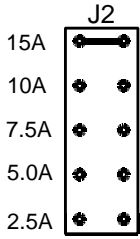

(1) 15A current range on KBRG-225D only.

- C. J3 - Motor Armature Voltage** – Select the desired armature voltage by placing J3 in the proper position, "90" or "**180**." Note: For 115 volt AC line input, the armature voltage must be set to "90." For 230 input, the armature voltage normally is set for "180." However, it is also possible to set the armature voltage to "90" for step-down operation.

FIG. 3 – AC LINE VOLTAGE JUMPER SETTING

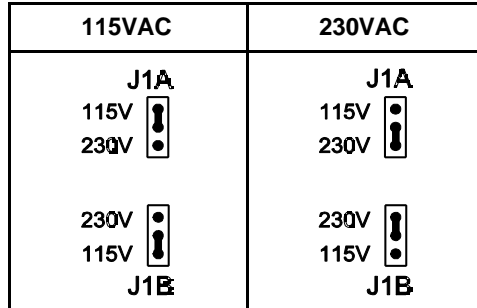

FIG. 4 – MOTOR ARMATURE VOLTAGE JUMPER SETTING

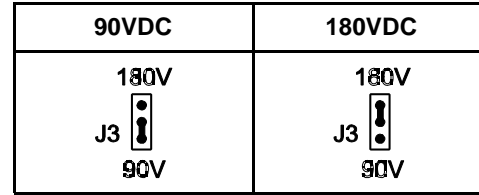

TABLE 5 – RELATIONSHIP of AC LINE INPUT AND MOTOR VOLTAGE with J1A, J1B and J3 JUMPER POSITION

AC INPUT VOLTAGE	J1A, J1B POSITION	J3 POSITION	MOTOR VOLTAGE
115	115	90	90
230	230	180	180
230	230	90*	90*

*A 90VDC motor can be used with a 230VAC line. However, speed range may be reduced and motor overheating may result.

- D. J4 - Tach-generator Voltage** – (Note: Selection of the jumper position is not required if armature feedback is used.) Place J4 jumper in the position "7V", "20/30V," "**50V**" that corresponds to the tach-generator voltage in Volts/KRPM. Note: The tach voltage jumper position is based on motor speed of 1,800 RPM.

For example, if the tach is 25V/KRPM and the motor speed is 3,600 RPM, use the "50V" J4 position. For other tach-generator voltages and motor speeds, an external resistor (RT) may be used as follows.

- i. Install resistor in series with either tach-generator lead.
- ii. Place J4 in "7V" position.
- iii. The value of RT is calculated as follows.

$$RT = [(5.4 \times V_t \times S) - 68,000]$$

Choose the closest standard watt resistor value to the calculated value

$$VT = \text{Tach voltage in volts/1000 RPM}$$

$$S = \text{Base Speed of motor in RPM}$$

- E. J5 - Feedback Type** – The KBRG can be operated in either armature feedback "**AFB**" or tach-generator feedback "**TFB**." Armature feedback provides adequate load regulation for most applications. For very precise performance, tach-generator feedback "**TFB**" should be used. (Note: If tach feedback is desired, an external DC tach-generator must be used and connected as per instructions.) (See section V J, p. 12 for tach-generator wiring.) (Note: The IR Comp trimpot must be set to the minimum setting [CCW] for tach feedback.)

- F. J6 - Current Limit (CL) Mode** – The KBRG contains electronic current limiting that limits the maximum DC current to the motor. (Note: Current Limit is established with the selection of the J2 position and the setting of the Forward and Reverse CL trimpots "FWD CL" and "REV CL.")

Two modes of current limit are provided:

1. Timed Current Limit "TCL" – Turns the drive off after a preset time. (The time period is adjustable with the TCL trimpot from 1-15 seconds and is factory set for approximately 5 seconds.) In order for the Timed CL feature to operate, the Start/Stop circuit must be wired. To restart drive after it has "timed out," the Start button must be pressed.

Application Note: The "TCL" feature cannot be used in either torque mode, since nuisance tripping will occur.

2. Non-Timed Current Limit "NTCL" – In this mode, the drive will reach preset Current Limit during overload and stay at that level until drive is turned "off" or fuse blows. If Non-Timed CL is desired, move jumper J6 from the factory set "TCL" position to the "NTCL" position.

IV. MOUNTING.

Mount the KBRG in a vertical position (connection terminals in down or up position) on a flat surface free of moisture, metal chips, or corrosive atmosphere. (Note: If drive is mounted in other than a vertical position, decrease maximum allowable ambient temperature by 10 °C.) (See Outline Drawing fig. 1, p. 3.) A 5K ohm Remote Speed potentiometer is provided with each control. Install potentiometer using hardware provided. Be sure to install insulating disk between potentiometer and inside of front panel.

Enclosure – When mounting the KBRG in an enclosure, it must be large enough to allow for proper heat dissipation. A 12"x12"x24" enclosure is suitable for the KBRG-240D at full rating and a 12"x24"x36" enclosure is suitable for the KBRG-225D at full rating. Smaller enclosures may be used if full rating is not required.

V. WIRING. **Warning! Read Safety Warning before attempting to use this control.**

Warning! To avoid erratic operation do not bundle AC Line and motor wires with potentiometer, voltage following, enable, inhibit or other signal wiring. Use shielded cables on all signal wiring over 12" (30 cm) – Do not ground shield.

Wire control in accordance with National Electric Code requirements and other local codes that apply. The KBRG contains a single AC line fuse wired in series with terminal L1. Be sure to fuse each conductor which is not at ground potential (do not fuse neutral or grounded conductors). (See section VI, p. 12, for fuse information.) Wire control in accordance with connection diagram (see fig. 8 and 9, p. 11). A separate AC line switch or contactor must be wired as a disconnect switch to control so that contacts open each ungrounded conductor. See table 6.

TABLE 6 – TERMINAL BLOCK WIRING INFORMATION

Terminal Block Designation	Connection Designation	Supply Wire Gauge*		Maximum Tightening Torque (lbs inch)
		Minimum	Maximum	
TB1 (Power Board)	F+, F-	22	14	3.5
TB1 (Logic Board)	Logic Connections	22	14	3.5
TB2	L1, L2, M1, M2	18	10	12

*AWG, Cu wire only.

- A. AC Line** – Connect AC line to terminals L1 and L2. (Be sure jumpers J1A and J1B are set to match the AC line voltage used. See table 4, p. 6.) See fig. 6, p. 10.
- B. Motor Armature** – Connect motor armature to terminal M1 and M2. (Be sure jumper J3 is set to match motor voltage. See table 4, p. 6.) See fig. 6, p. 10.

FIG. 5 – MECHANICAL SPECIFICATIONS INCHES
[mm]

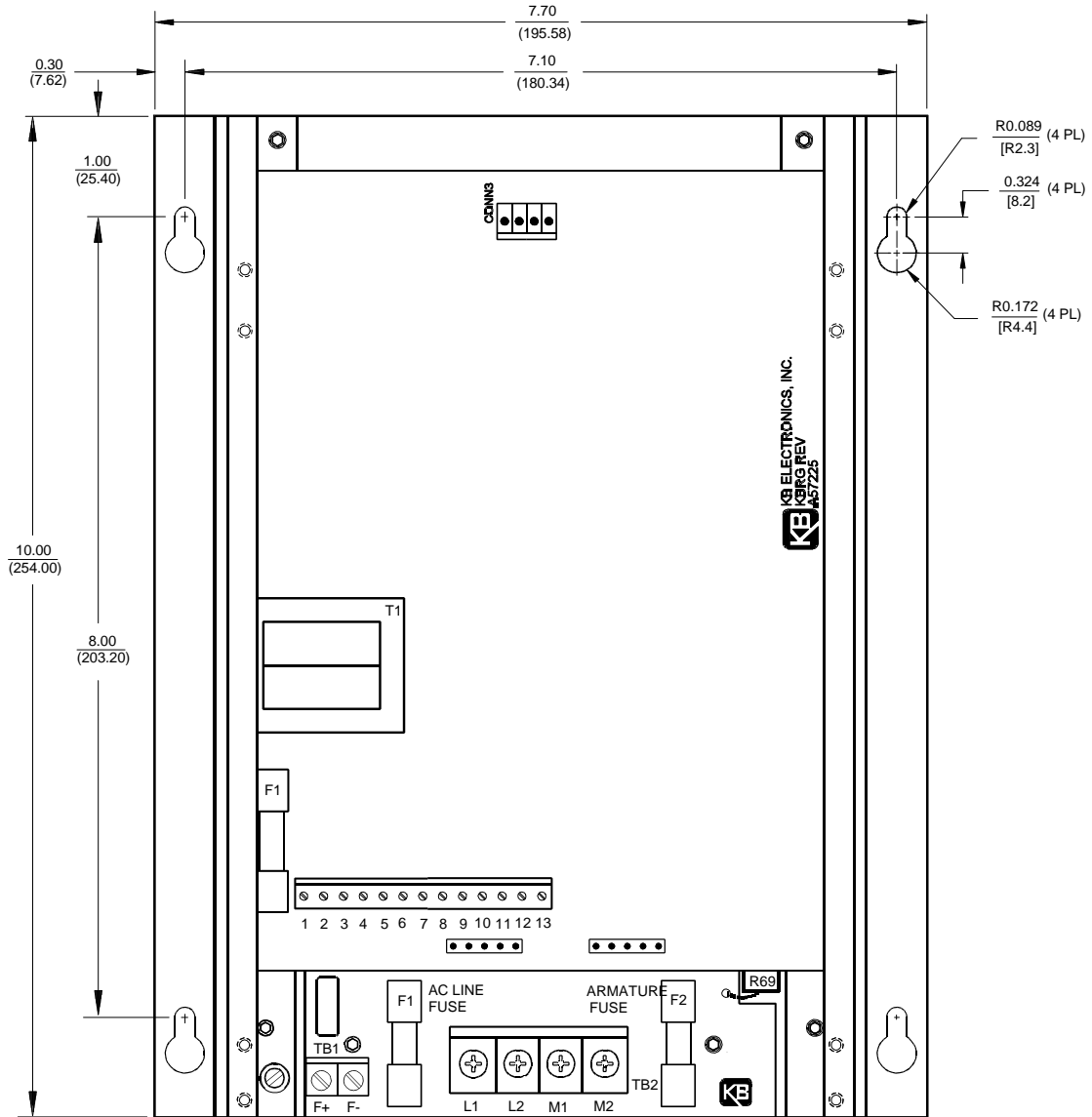

DWG#: C3900-1-00096

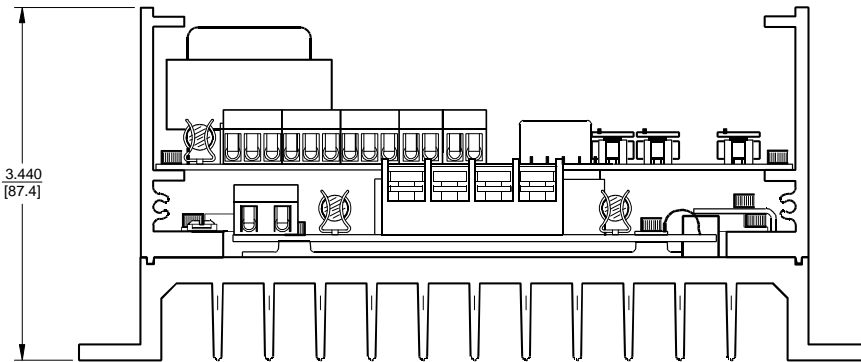

NOTE: CONTROL SHOWN ABOVE IS MODEL KBRG-225D.
HEIGHT OF MODEL KBRG-240D IS 2.57" (65 mm).

C. Field (For Shunt Wound motors **only**) – Do not use F+ and F- terminals for any other motor type. Connect motor shunt field to terminals F+ and F- for 90VDC motors with 100VDC fields and 180VDC motors with 200VDC fields. For motors with half voltage fields, 90VDC motors with 50VDC fields and 180VDC motors with 100 VDC fields, connect field to terminals F+ and L1. See table 7 for summary of Field Connections.

FIG. 6 – AC LINE AND ARMATURE CONNECTION

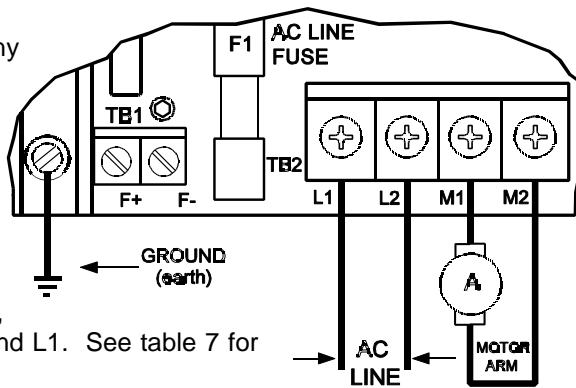

CAUTION – Shunt-Wound motors may be damaged if field remains connected without motor rotating for an extended period of time.

FIG. 7A – FULL VOLTAGE FIELD

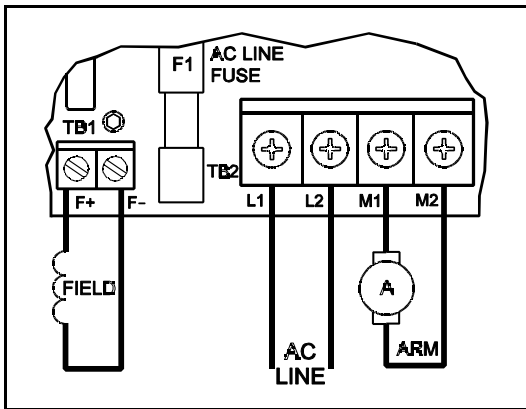

FIG 7B – HALF VOLTAGE FIELD

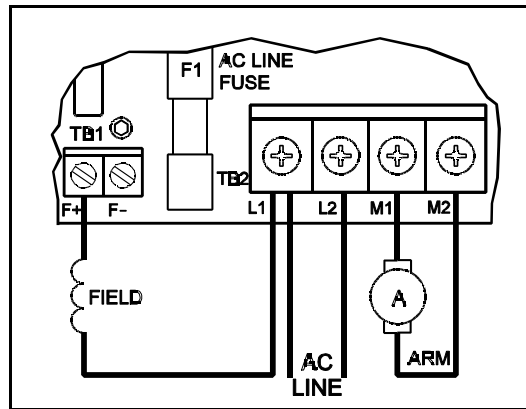

TABLE 7 – FIELD CONNECTIONS (Shunt Wound Motors Only)

AC Line Voltage (VAC)	Motor Voltage	Field Voltage (VDC)	Field Connection
115	90	100	F+, F-
115	90	50	F+, L1
230	180	200	F+, F-
230	180	100	F+, L1
230	90*	100	F+, L1

*Step down operation (see sec. III C, p. 6).

D. Ground – Be sure to ground (earth) the control via green screw located on chassis.

E. Main Speed Potentiometer – The main speed potentiometer can be connected in several ways using terminals "10," "11," "12," "13." (A 5K ohm potentiometer is supplied with control. A 10K potentiometer can also be used.) **[WARNING! Terminals "10," "11," "12" and "13" are not isolated from AC line. Do not ground (earth).]**

- i. Unidirectional operation only – Connect potentiometer to terminals "10," "12," "13" for forward direction. (To operate in reverse direction, connect to "11," "12," "13.")
- ii. Bidirectional operation using reversing contacts – Connect to terminals "10," "11," "12," "13" as per fig. 8, p. 11.
- iii. Bidirectional operation with potentiometer – Connect potentiometer to terminals "10," "11," "12" as per fig. 8, p. 11.

FIG. 8 – MAIN SPEED POTENTIOMETER CONNECTIONS

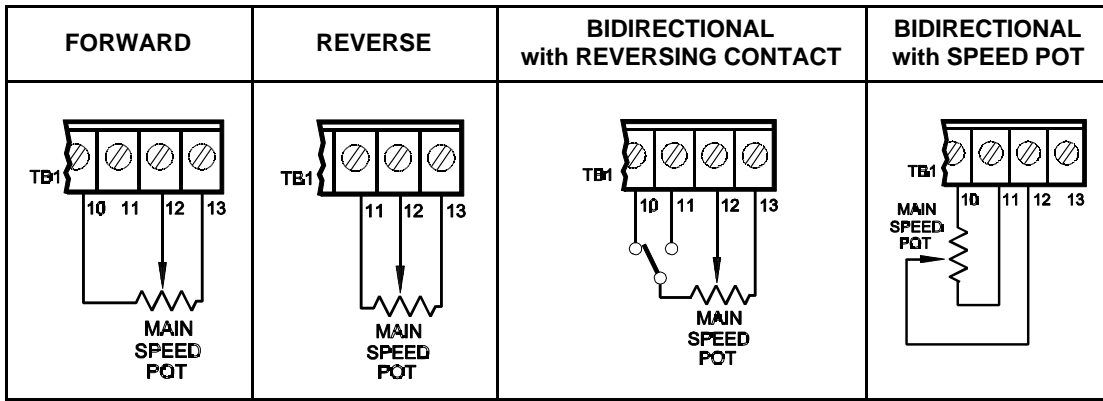

F. **Voltage Following** – An *isolated* analog voltage can be used in lieu of main speed potentiometer. Connect signal to terminals "12" and "13." Note: Terminal "13" is common. A positive signal with respect to terminal "13" will produce a positive output to motor. A negative signal with respect to terminal "13" will produce a negative output. A 0 to ± 10 VDC is required to operate control from 0 to \pm full output. **WARNING! Do not common multiple drives without a signal isolator.** A bipolar signal isolator, SI-4X, is available as an option from your distributor.

FIG. 9A – VOLTAGE FOLLOWING

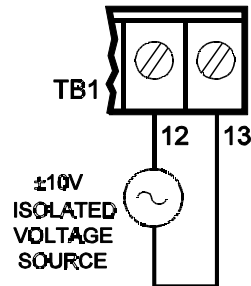

G. **Enable** – Control may be electronically started and stopped with Enable circuit. Connect Enable contacts between terminals "8" and "9." When terminals "8" and "9" are joined, control is in "ENABLE" state. When terminals "8" and "9" are open, control is in "INHIBIT" state. (See fig. 9B.)

IMPORTANT! If Enable is not used, a jumper must be installed between terminals "8" and "9" or control will not operate. (See Safety Warning on page 2.)

H. **Start/Stop Circuit** – A standard 3-wire start/stop circuit is provided (terminals "5," "6" and "7"). This allows a remote momentary 2-button start/stop station to be installed. In this mode, if AC power is removed, the start button must be used to restart the control. Also, when the control is in the Timed Current Limit mode (J6 set to TCL) and has "timed out," it must be restarted using the start button. **IMPORTANT! If the Start/Stop mode is not required, a jumper must be installed between terminals "5" and "7."** (Note: The Timed CL function will operate only when the start/stop mode is used.) Control will not start using Start/Stop circuit if AC line voltage is below 20% of nominal (95 volts on 115V circuit and 190V on 230V circuit). (See Safety Warning on page 2.)

FIG. 9B – ENABLE

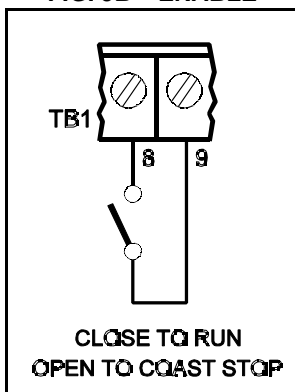

FIG. 9C – START/STOP CIRCUIT

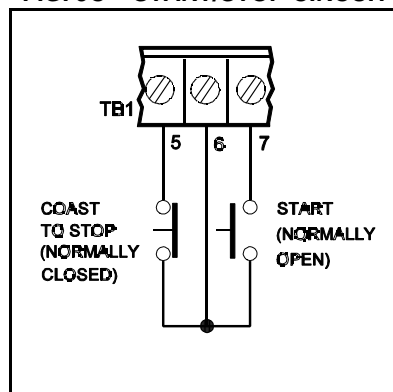
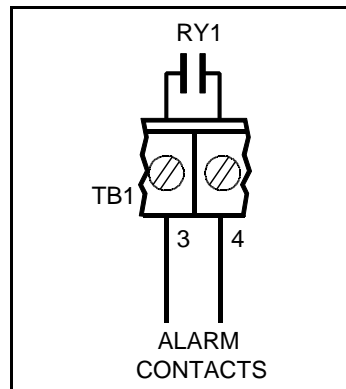

FIG. 9D – ALARM CONTACTS



- I. **Alarm Contacts** – S.P.S.T. relay contacts (terminals "3" and "4") are used to signal a warning or to shut other equipment down if control goes to an Inhibit state. Rating of contacts are 1A-28VDC, .5A-115VAC. See table 8 for relay control state vs contact state. (See fig. 9D, p. 11.)

TABLE 8 – CONTROL STATE vs RELAY CONTACT STATE

Description of Control State	Relay Contact State	
	Using Start / Stop	Start / Stop Bypassed
No power to control	O	O
Power applied	O	X
Control in Stop mode	O	NA
Control is started with Start button	X	NA
Control has "Timed Out" in TCL	O	NA
O – Open, X – Closed, NA – Not Applicable		

- J. **Tach-generator Input** – Terminals "1" and "2" are used to connect a DC tach-generator and should be used only when control is in tach-generator feedback mode (J5 is in "TFB" position). Connect the positive (+) tach lead to terminal "1" and the negative (-) tach lead to terminal "2." Note: The tach-generator polarity must be phased so that the tach voltage is positive (+) on terminal "1" when the voltage on terminal "12" is positive (+). If the tach-generator is wired backwards, the control will run at full speed only.

FIG. 9E – TACH-GENERATOR CONNECTION

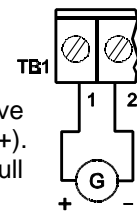

VI. FUSING.

A. Power Board.

1. AC Line Fuse – The Power Board on all models contains a single AC line fuse (F1) 25A for KBRG-225D and 20A for KBRG-240D) which protects the unit from catastrophic failure. CAUTION: Most electrical codes require that each ungrounded conductor contain fusing. Separate branch circuit fusing may be required. Check local electrical codes.
2. Armature Fuse – An armature fuse (F2) is also provided with a rating equal to the maximum RMS rating of the control. It is recommended that the correct size armature fuse be installed, depending on the rating of the motor and form factor (RMS/AVG current). Fuse type should be Littelfuse 326 ceramic or Buss ABC, or equivalent. A fuse chart is presented on page 13 (table 9) which suggests appropriate armature fuse ratings. However, the specific application may require larger fuse ratings based on ambient temperature, CL set point and duty cycle of operation (see table 9, p. 13). Fuses may be purchased from your distributor.

- B. **Control Board Fuse** – The logic control board contains a low amperage fuse (.150 amp Littelfuse 3AG normal blo or equivalent) which protects the control transformer and other components against catastrophic failure. Under normal circumstances, this fuse should never blow. (See fig. 1, p. 3, for location.)

VII. OPERATION.



WARNING! Read Safety Warning on page 2 before attempting to operate or severe injury or death can result.

After the KBRG has been set up (Jumpers are in appropriate position) and the drive has been properly wired, the startup procedure can begin. Before initially starting, be sure main speed pot is in minimum position. (Set main speed pot to full CCW position if wired for unidirectional operation and to center position if wired for bidirectional control. (See fig. 8, p. 11.)

TABLE 9 – ARMATURE FUSE CHART (F2 Power Board)

Motor Horsepower		Approx. DC Motor Current Amps	Fuse Rating (AC Amps)
90VDC	180VDC		
1/8	1/4	1.3	2
1/6	1/3	1.7	2
1/4	1/2	2.5	4
1/3	3/4	3.3	5
1/2	1	5.0	8
3/4	1	7.5	12
1	2	10.0	15, 20*
1	3	15.0	25

* Use higher rated fuse for high ambient temperature or when rapid starting and stopping occur.

Start control by applying AC power. Enable circuit must be closed for control to start (jumper terminals "8" and "9"). If wired for start/stop operation, press start switch. If not wired for start/stop, terminals "5" and "7" must be jumpered. Rotate main speed potentiometer to control motor speed.

VIII. TRIMPOT ADJUSTMENTS.

The KBRG contains many trimpots which have been factory adjusted for most applications. (See table 2, p. 4. for factory settings.) (Note: fig. 1, p. 3 presents the various trimpots with their locations. They are shown in the approximate adjustment position.) Some applications may require readjustment of trimpots in order to tailor control to exact requirements. Readjust trimpots as follows:

A. Forward Acceleration (FWD ACCEL) and Reverse Acceleration (REV ACCEL) – The FWD ACCEL trimpot determines the amount of time it takes the control voltage to reach full output in the forward direction. It also determines the amount of time it takes for the control voltage, in the reverse direction, to reach zero output. (FWD ACCEL also sets the Reverse Decel.)

The REV ACCEL trimpot determines the amount of time it takes the control voltage to reach full output in the reverse direction and the time it takes for the control voltage, in the forward direction, to reach zero output. (REV ACCEL is the Forward Decel.)

The FWD and REV ACCEL trimpots are factory adjusted to 1 second. The acceleration times are adjustable to a maximum of 15 seconds. (See fig. 10 for graphic representation of ACCEL.)

Note: The FWD and REV CL trimpots settings may override the rapid accel and decel settings.

Note: A 4-quadrant ACCEL/DECEL accessory module is available as an option. It provides separate control of FORWARD acceleration and deceleration and REVERSE acceleration and deceleration.

FIG. 10 – ACCEL TRIMPOT ADJUSTMENT

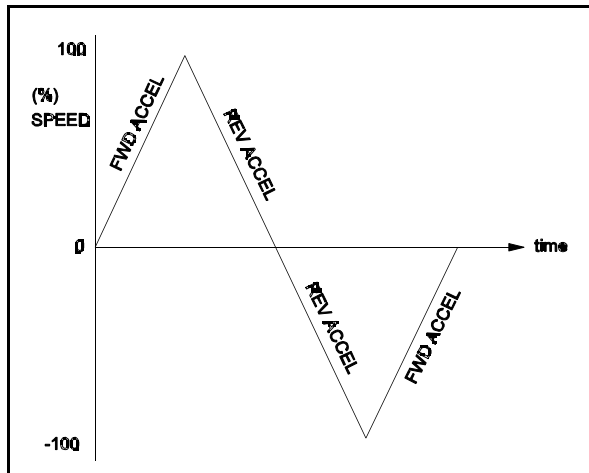

B. Offset (OFFSET) – This trimpot determines the amount of bias in the forward or reverse direction. The trimpot is factory set to provide approximately zero offset, which means neither the forward nor the reverse speed is favored. (See fig. 11 which illustrates the action of the OFFSET trimpot.)

C. Deadband (DB) – The DB trimpot sets the amount of main speed potentiometer rotation required to initiate control voltage output. It is factory adjusted to approximately 25% of rotation.

The DB trimpot also determines the amount of delay that will occur before regeneration starts. (Regeneration occurs when the applied load torque is in the same direction as the motor rotation.)

To readjust the DB to factory setting:

- i. Set Main Speed pot to zero speed position.
- ii. Set DB trimpot to full CCW position.
- iii. Adjust DB trimpot CW until motor hum is eliminated.

(See fig. 12 for graphic illustration of the DB trimpot.)

Note: If the deadband trimpot is set too low (CCW direction), the motor may oscillate between forward and reverse. Adjust deadband trimpot CW until the instability disappears. (Oscillation may also occur due to response setting. See section VIII, G, p. 15.)

D. Forward Current Limit (FWD CL) and Reverse Current Limit (REV CL) Trimpots – These trimpots are used to set the maximum amount of DC current that the motor can draw in both the forward and reverse directions. The amount of DC current determines the amount of maximum motor torque in both the Speed Control Mode and Torque Control Mode. They are factory set at 150% of the current established by the jumper J2 setting. Readjust the CL trimpots as follows:

- i. Turn CL trimpot to MIN (CCW) position. Be sure jumper J2 is in proper position approximately equal to the motor DC ampere rating.
- ii. Wire in a DC ammeter in series with armature lead. Lock shaft of motor.
- iii. Apply power. Rotate CL trimpot CW until desired CL setting is reached (factory setting is 1.5 times rated motor current). Be sure control is in Forward direction for FWD CL trimpot adjustment and likewise with REV CL.

WARNING! Do not leave motor shaft locked for more than 2 – 3 seconds to prevent motor damage.

CAUTION: Adjusting the CL above 150% of motor rating can cause overheating and demagnetization of some PM motors. Consult motor manufacturer.

FIG. 11 – OFFSET TRIMPOT ADJUSTMENT

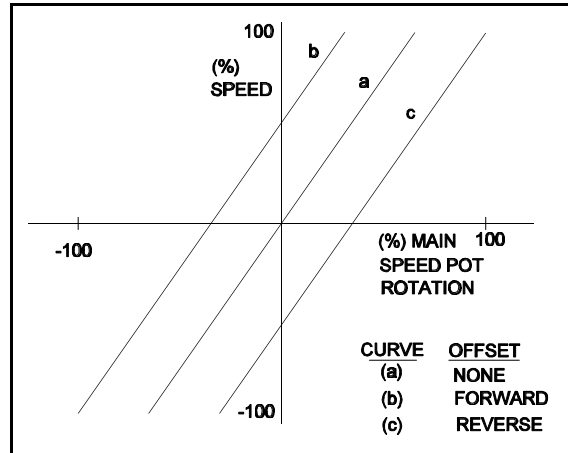
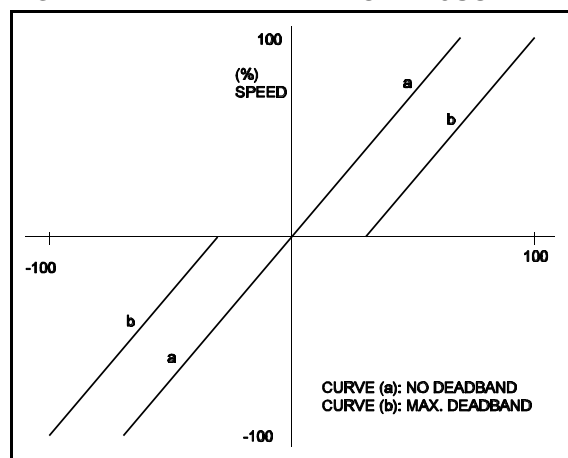

FIG. 12 – DEADBAND TRIMPOT ADJUSTMENT



E. IR Compensation (IR Comp) – The IR Comp is used to stabilize motor speed under varying loads. (Note: If control is in Tach Feedback mode, the IR Comp should be set to minimum - CCW.)

Readjust the IR Comp trimpot as follows:

- i. Run motor at approximately 30-50% of rated speed under no load and measure actual speed.
- ii. Load motor to rated current. Rotate IR Comp trimpot so that loaded speed is the same as the unloaded speed measured in the previous step.

Control is now compensated so that minimal speed change will occur over a wide range of motor load. [Note: Too much IR Comp will cause unstable (oscillatory) operation.]

F. Maximum Speed (MAX) – The MAX trimpot is used to set the maximum output voltage of the control which, in turn, sets the maximum speed of the motor. In the Torque Control Mode, the MAX trimpot setting determines the unloaded motor speed. Adjust the MAX trimpot as follows:

- i. Rotate Main Speed potentiometer to full speed (CW).
- ii. Adjust MAX trimpot to desired maximum motor speed.

(Note: Do not exceed maximum rated RPM of motor since unstable operation may result.)

G. Response (RESP) Trimpot – This trimpot determines the dynamic response of the control. The factory setting is approximately 50% of full rotation. The setting may be increased if a faster response is required. (Note: If response is made too fast, unstable operation may result.)

H. Timed Current Limit (TCL) Trimpot – Trimpot is functional only when control is wired for 3-wire Start/Stop and J6 is in the TCL position. The TCL trimpot sets the delay time for the Timed Current Limit. The trimpot is adjustable over a time range of 1-15 seconds and is factory set for approximately 5 seconds. Calibrate the TCL trimpot by setting the trimpot to the approximate desired delay time as follows: (See table 10.)

TABLE 10 – CURRENT LIMIT TIMER SETTINGS

Approx. Trip Time (Secs)	Trimpot Position
1	Full CCW
8	Midway
15	Full CW

IX. FUNCTION INDICATOR LAMPS.

A. LED 1 Power On (PWR ON) – Indicates that the drive is energized with the AC line.

B. LED 2 Current Limit (CL) – Indicates that the drive is in Current Limit. If set in the timed Current Limit mode (J6 set to "TCL") and has "timed out," the LED 2 will remain ON until the drive is restarted.

C. LED 3 Forward Enable (FWD EN) – Indicates that the drive is engaged in the forward direction. [Enable circuit closed (terminals "8" and "9" joined), the start circuit initiated and a "forward" speed command.] The FWD EN lamp will also be lighted in the reverse direction if the control is in regeneration.

D. LED 4 Reverse Enable (REV EN) – Indicates that the drive is engaged in the reverse direction. [Enable circuit closed (terminals "8" and "9" joined), the start circuit initiated and a "reverse" speed command.] The REV EN lamp will also be lighted in the forward direction if the control is in regeneration.

X – LIMITED WARRANTY

For a period of 18 months from date of original purchase, KB will repair or replace without charge devices which our examination proves to be defective in material or workmanship. This warranty is valid if the unit has not been tampered with by unauthorized persons, misused, abused, or improperly installed and has been used in accordance with the instructions and/or ratings supplied. The foregoing is in lieu of any other warranty or guarantee, expressed or implied, and we are not responsible for any expense, including installation and removal, inconvenience, or consequential damage, including injury to any person, caused by items of our manufacture or sale. Some states do not allow certain exclusions or limitations found in this warranty so that they may not apply to you. In any event, KB's total liability, under all circumstances, shall not exceed the full purchase price of this unit. (rev 4/88)



KB ELECTRONICS, INC.

12095 NW 39th Street, Coral Springs, FL 33065 • (954) 346-4900 • Fax (954) 346-3377

Outside Florida Call **TOLL FREE** (800) 221-6570 • **E-mail** – info@kbelectronics.com

www.kbelectronics.com

(A40260) – Rev. C – 1/98